

CROSSPRO

OFF-ROAD

2023

v23.22.11.15

■ ABOUT US

A CROSSPRO, fundada em 2005, é uma empresa que se dedica ao fabrico de proteções e acessórios para o segmento de veículos de 2 e 4 rodas.

A paixão pela modalidade, a noção das exigências pela prática do desporto e o bom conhecimento de mecânica dos seus fundadores posicionaram a CROSSPRO neste segmento de mercado, marca que rapidamente ganha na Europa reconhecimento e reputação, fruto do trabalho e especial cuidado com a qualidade obtida na produção e desenvolvimento dos seus produtos. A constante procura por novas e inovadoras soluções permitiram expandir para outros mercados e atualmente assegurar a presença da marca a nível mundial.

Todo o processo produtivo é feito na unidade fabril com sede em Portugal e com recurso a mão de obra especializada, matéria prima da mais alta qualidade e tecnologia de ponta.

CROSSPRO, founded in 2005, is a company dedicated to the manufacture of protections and accessories for the 2 and 4 wheel vehicle segment.

The passion for motorized sport and the notion of its demands, through the practice of this sport, combined with the good mechanical knowledge of its founders, positioned CROSSPRO in this market segment. A brand that quickly gains recognition and reputation in Europe, the result of hard work and the special care taken with the quality obtained in the production and development of its products.

The constant search for new and innovative solutions made it possible to expand to other markets and currently ensure the brand's presence worldwide.

The entire production process is carried out in the factory located in

Portugal, using specialized labor, the highest quality raw materials and cutting-edge technology.

■ ABOUT OUR PRODUCTS

Os nossos produtos são submetidos a um rigoroso controlo de qualidade e testados em condições extremas, sendo adequados desde o utilizador convencional até ao utilizador profissional de alta competição. Garantem, portanto, uma máxima performance.

A aposta numa melhoria contínua, quer seja pela exigência das novas tendências de mercado, quer pelas necessidades dos nossos clientes, é um fator que nos distingue.

Temos como preocupação as necessidades dos nossos clientes, estando sempre atentos ao seu *feedback*, procurando antecipar e ajustar a nossa gama de produtos.

A mudança de instalações em 2017, agora com 5000m² de área coberta, aliada a um forte investimento estratégico em nova maquinaria, tais como corte a laser, célula de solda robotizada, máquina de lixar por planos, unidade de pintura eletrostática, máquina de dobrar tubo CNC, entre outras, bem como o *know-how* adquirido, projetou a entrada da CROSSPRO para novas áreas de negócio, com novas parcerias e novos desafios, alargando as suas valências no sector metalomecânico para variados tipos de produtos.

Our products are subjected to strict quality control and tested under extreme conditions, being suitable from the conventional user to the professional user of high competition. Therefore, they guarantee maximum performance.

The commitment to continuous improvement, whether due to the demands of new market trends or the needs of our customers, is a factor that distinguishes us.

Our main concern is the customer's needs, we are always in communication and attentive to their feedback, seeking to anticipate and adjust our product range.

The change of facilities in 2017, now with 5000m² of covered area, combined with a strong strategic investment in new machinery, such as a laser cutting unit, robotic welding cell unit, flat sanding machine, electrostatic painting unit, CNC tube bending, among others, as well as the team's know-how, projected CROSSPRO's entry into new business areas, with new partnerships and new challenges, expanding its valences in the metalworking sector to various types of products.

CROSSPRO is, for all these reasons, synonymous of Quality and Reliability.

CROSSPRO é sinónimo de qualidade e fiabilidade.



Management System
ISO 9001:2015

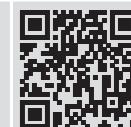

www.tuv.com
ID 910507726

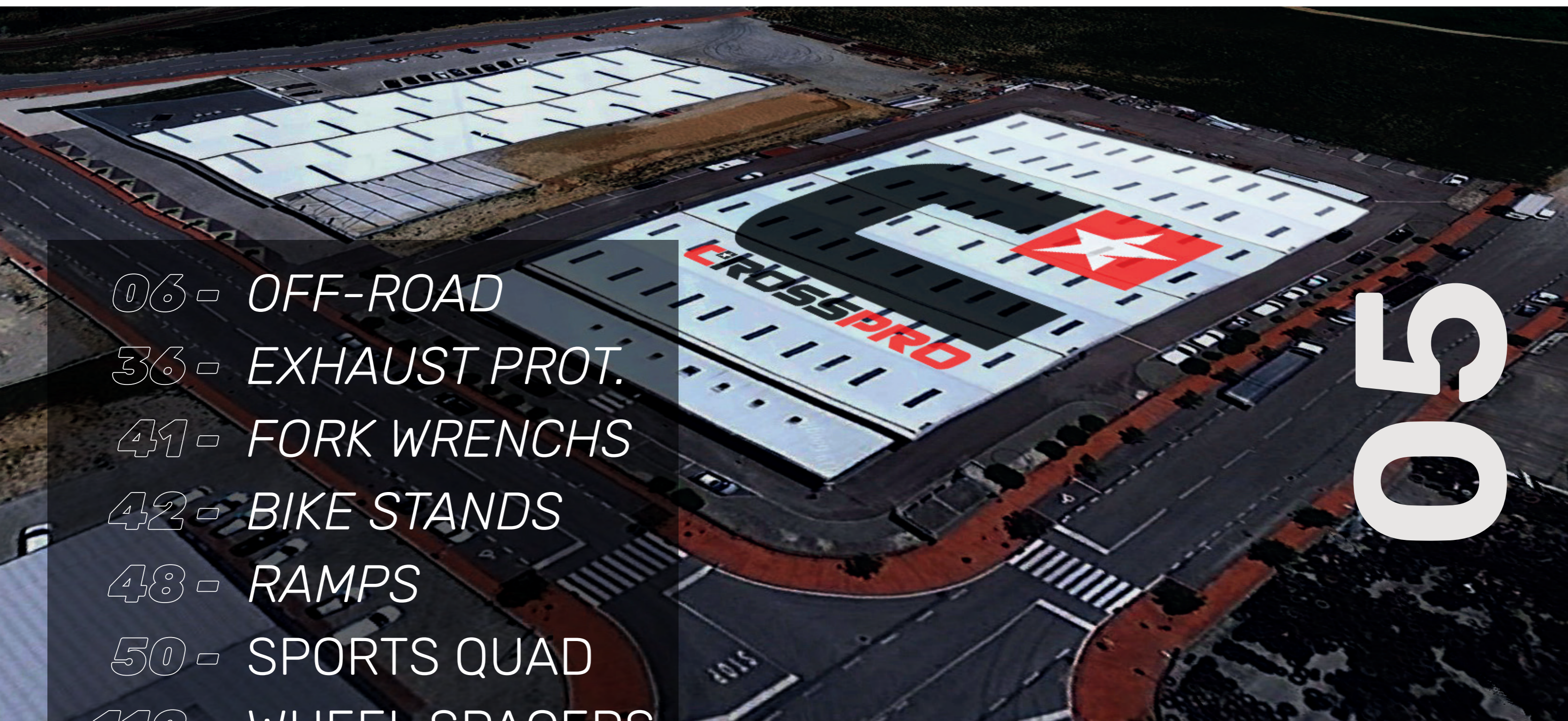

- 06 - OFF-ROAD
- 36 - EXHAUST PROT.
- 41 - FORK WRENCHS
- 42 - BIKE STANDS
- 48 - RAMPS
- 50 - SPORTS QUAD
- 112 - WHEEL SPACERS
- 116 - UTILITY ATVs
- 124 - SIDE by SIDE



CONTENT
table of

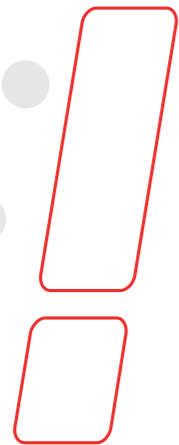

RIEJU FACTORY

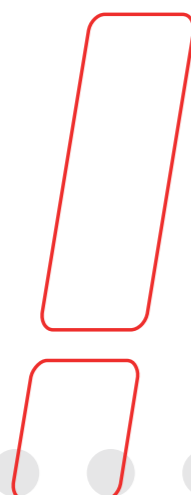
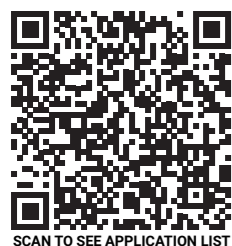

HARD LINK DTC ENGINE GUARD

• DTC COLOR AVAILABLE:

Proteções de motor DTC com proteção de link reforçado

A máxima exigência dos nossos clientes, as novas tendências e a filosofia de melhoria contínua, naturalmente levaram ao upgrade das proteções de DTC desenvolvidas.

A nova protecção, além do reforço da zona do link, tem um reforço nas zonas do quadro, aumentando a protecção da sua moto.

- Extra protecção na zona de link, agora com 12mm que reforçará a protecção desta zona sensível da sua moto
- De fácil aplicação, pode remover ou colocar ajustando a protecção à exigência de cada corrida
- Protecção ajustada e adequada a corridas com mais obstáculos
- Removível e de fácil substituição



DTC HARD engine guard with link reinforcement protection

The maximum demand of our customers, the new trends and the philosophy of continuous improvement, naturally led to the upgrade of the developed DTC protections.

The new protection, in addition to strengthening the link area, has a reinforcement in the areas of the frame, increasing the protection of your bike.

- Extra protection for the link, now with 12mm that will reinforce the protection in this sensible part of your bike
- Easy to apply, you can remove or putt adjusting the skidplate to the "hardness" of each race
- Protection adjusted to races with more obstacles
- Removable and easily replacable

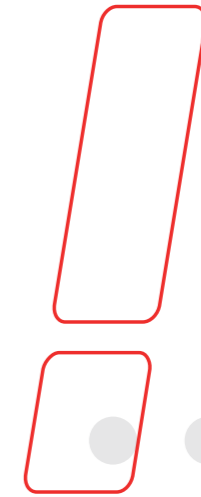

***OFF-ROAD
RACING
PROTECTION***



SCAN TO SEE APPLICATION LIST

LINK DTC ENGINE GUARD

Proteções de motor DTC com proteção de link

//Detetando a necessidade crescente de aumentar a proteção das motos, a CrossPro introduz na sua gama uma Proteção de Motor em DTC, que protege agora também o Link de Suspensão.
 // Uma peça única e completa para proteção da sua moto, carter, quadro e Link de suspensão.
 // Proteção extra para condições extremas
 // Testado em competição
 // Produzido em DTC da melhor qualidade com 6mm, sem solda, estas proteções de motor são 40% mais leves que o alumínio, não quebram e não causam vibrações, e muito mais resistente ao impacto.
 // Disponível em diferentes cores

DTC enduro engine guard with link protection

//Noting the increasing necessity to protect more the bikes, CrossPro introduce in the range the DTC Engine Protection, that now also protect the Suspension Link.
 //One complete piece for protect your bike for frame, carter and suspension link protection
 //Extra protection for extreme conditions
 //Made by 6mm best quality DTC, with no welding, these engine guards are 40% lighter than aluminum, dont break and dont cause vibrations, and is much more resistant to impact.
 //Available in different colors



•2CP193_

- » Replace the (****) for the code of the desired color Example: Red Color 2CP19301830500
 - » Substituir os (****) pelo código de cor pretendida.Exemplo: para a cor vermelha 2CP19301830500
- | | | | | | |
|-------------|-----------|--------------|--------------|----------------|----------------|
| ● »0300 | ● »0400 | ● »0500 | ● »0600 | ● »0700 | ● »0900 |
| Black Preto | Blue Azul | Red Vermelho | White Branco | Yellow Amarelo | Orange Laranja |



ENDURO DTC ENGINE GUARD

Proteções de motor DTC enduro

//Testado em competição, estas proteções de motor oferecem a melhor proteção para o motor e para o quadro de sua moto.
 //Produzido em DTC da melhor qualidade com 6mm, sem solda, estas proteções de motor são 40% mais leves que o alumínio, não quebram e não causam vibrações, e são muito mais resistente ao impacto.
 //Disponíveis em diferentes cores

DTC enduro engine guard

//Tested in competition, these engine guards offer you the best protection for the engine and for the frame of your bike.
 //Made by 6mm best quality DTC, with no welding, these engine guards are 40% lighter than aluminum, don't break and don't cause vibrations, and is much more resistant to impact.
 //Available in different colors



•2CP085_



SCAN TO SEE APPLICATION LIST

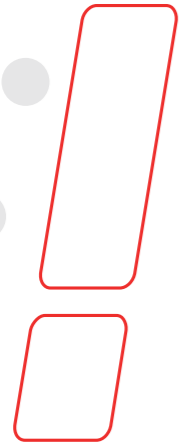

**FANTIC
FACTORY
TEAM E50
RACING**





- » Replace the (****) for the code of the desired color Example: Red Color 2CP07901830500
- » Substituir os (****) pelo código de cor pretendida.Exemplo: para a cor vermelha 2CP07901830500

- »0300 Black Preto
- »0400 Blue Azul
- »0500 Red Vermelho
- »0600 White Branco
- »0700 Yellow Amarelo
- »0900 Orange Laranja



MX DTC ENGINE GUARD

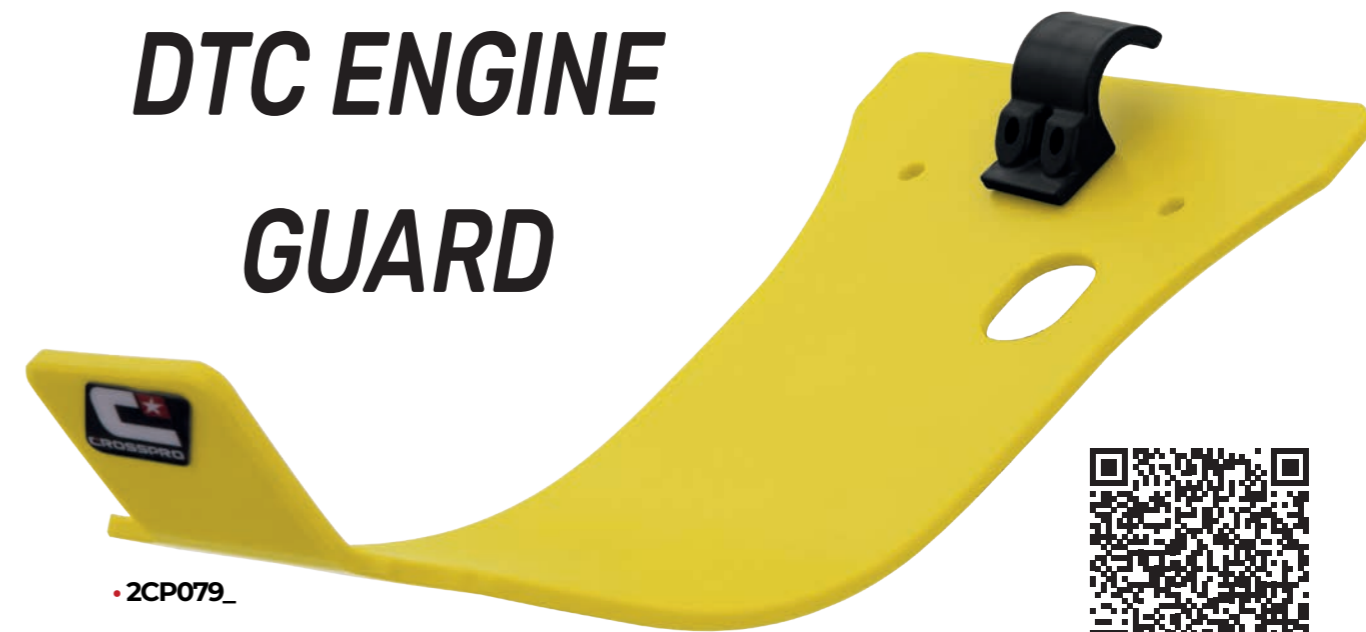

•2CP079_



SCAN TO SEE APPLICATION LIST

Proteções de motor DTC motocross

//Testado em competição, estas protecções de motor oferecem a melhor protecção para o motor e para o quadro de sua moto.
 //Produzido em DTC da melhor qualidade com 6mm, sem solda, estas protecções de motor são 40% mais leves que o alumínio, não quebram e não causam vibrações, e são muito mais resistente ao impacto.
 //Disponíveis em diferentes cores você pode escolher agora as melhores protecções de sempre para a sua moto.

DTC motocross Engine Guard

//Tested in competition, these engine guards offer you the best protection for the engine and for the frame of your bike.
 //Made by 6mm best quality DTC, with no welding, these engine guards are 40% lighter than aluminum, don't break and don't cause vibrations, and is much more resistant to impact.
 //Available in different colors



Wil Ruprecht E2 World Champion #57

**TM BOANO
FACTORY
RACING**



2CP059_



ENDURO ALUMINUM ENGINE GUARD

Protecções de motor enduro em alumínio

//As Protecções de Motor de Enduro da Crosspro oferecem a máxima protecção, sendo extremamente leves
//Cobrem totalmente o motor da sua moto, garantindo a máxima protecção contra impactos e projecções de pedras
//Produzidas em alumínio da mais alta qualidade, com espessura de 4mm

Enduro aluminum engine guard

//These aluminum skid plates offer the maximum of protection for a minimum weight
//They wrap around the bottom and both sides of the engine providing your bike with perfect protection against rocks
//Made by best quality aluminum, with a thickness of 4mm



Available in various colors



See page: 147



SCAN TO SEE APPLICATION LIST

> Replace the (****) for the code of the desired color Example: Red Color 2CP05900510007

> Substituir os (****) pelo código de cor pretendida:Exemplo: para a cor vermelha 2CP05900510007

»0001
Ice Matte
Ice Polish

»0002
Polish
Polido

»0003
Neutral
Natural

»0004
Black
Preto

»0011
Blue
Azul

»0007
Red
Vermelho

»0006
White
Branco

»0008
Yellow
Amarelo

»0010
Orange
Laranja

»0009
Green
Verde





**HERO
MOTOSPORTS
TEAM RALLY**



JOAQUIM RODRIGUES JR



MX ALUMINUM ENGINE GUARD



Protecções de motor motocross em alumínio

//As protecções de motor CrossPro de Motocross e Supermoto, asseguram a máxima protecção ao seu motor, permitindo deslizar sobre todos os obstáculos
//As protecções protegem também a parte inferior do quadro da moto.
//A máxima protecção, a simplicidade de montagem e a qualidade final do produto, são as principais razões pelas quais deverá equipar a sua moto com as protecções de motor CrossPro
//Produzidas em alumínio da mais alta qualidade, com espessura de 4mm

Motocross aluminum engine guard

//CrossPro motocross and supermoto plates give your engine and lower frame, the protection they need helping you glide over obstacles
//Our coverage, simplicity of mounting, and product finally quality are the reasons why you should equip your bike with CrossPro glide
//Made by best quality aluminum, with a thickness of 4mm



•2CP06L



SCAN TO SEE APPLICATION LIST

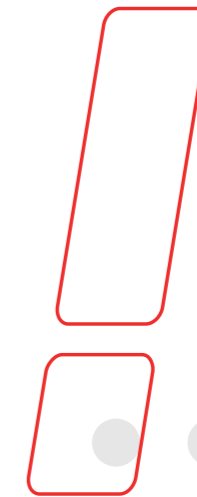

RIGO
RACING

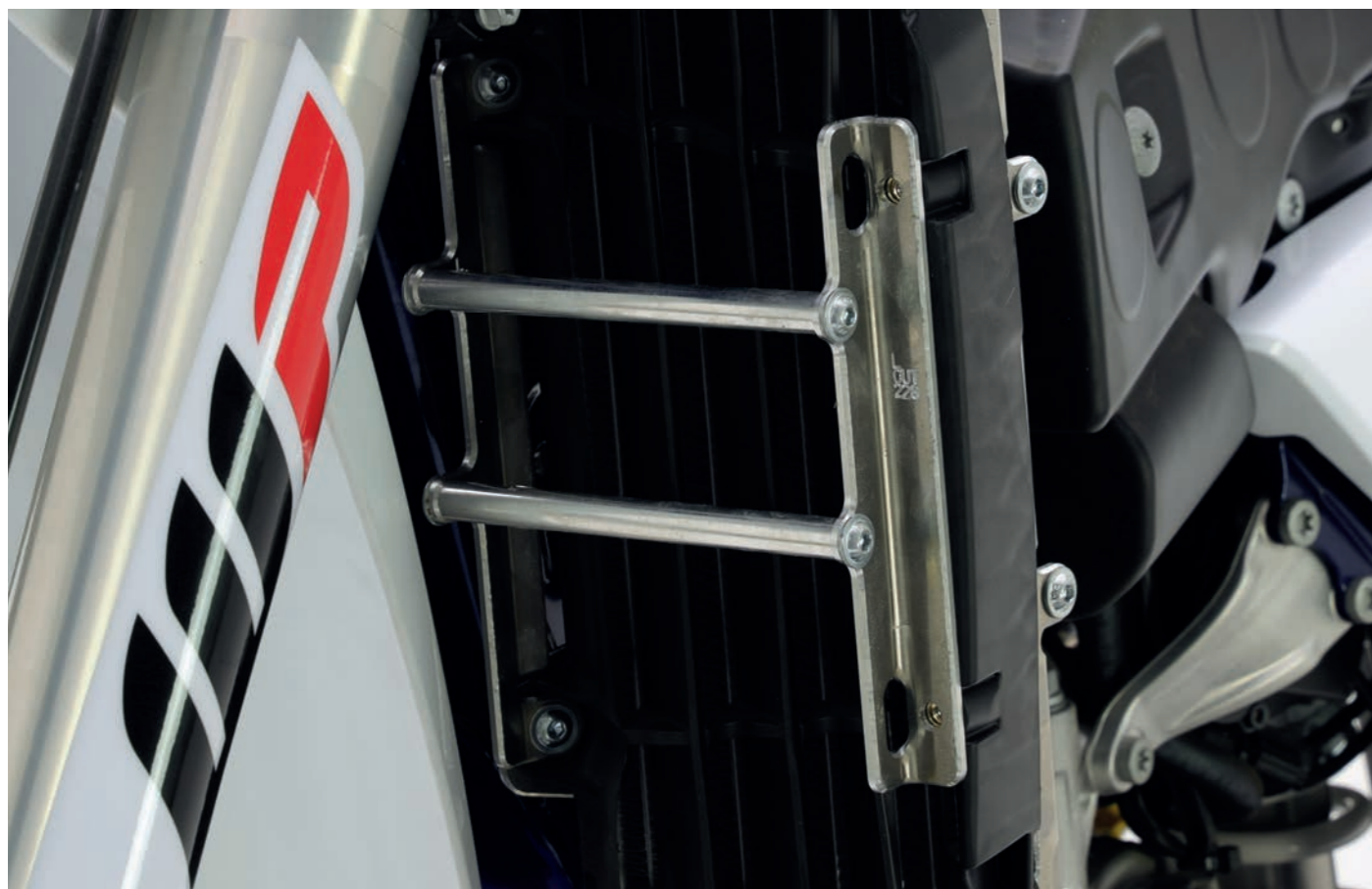

ALUMINUM

RADIATOR GUARD

HARD MODEL AVAILABLE FOR KTM, HUSQVARNA & GASGAS

Available in various colors
See page: 147



•2CP060_



SCAN TO SEE APPLICATION LIST

Protecções de radiador em alumínio

//As protecções de radiador Light CrossPro foram desenvolvidas para proteger o sistema de refrigeração (a parte mais frágil e importante da sua moto). Não obstrui o fluxo de ar necessário para o devido arrefecimento
//Desenhado como uma espécie de "Concha", a protecção de radiador assegura um perímetro de segurança, sem que os seus pontos de fixação estejam em contacto directo com o radiador. A fixação é efectuada ao quadro da moto.
//Com este perímetro de segurança, os impactos nunca serão transmitidos directamente ao radiador
//Produzidas em alumínio da mais alta qualidade, com espessura de 3mm.

Radiator aluminum guard

//The CrossPro radiator were specially designed to protect your Cooling System, your bike's most fragile and important component - without obstructing airflow to the radiator
//Designed as a "radiator roll cage", the CrossPro radiator protection secures a perimeter around the radiator, without its fixation points are in direct contact with the radiator
//With this security perimeter, hard impacts won't affect your radiator
//Made by best quality aluminum, with a thickness of 3mm

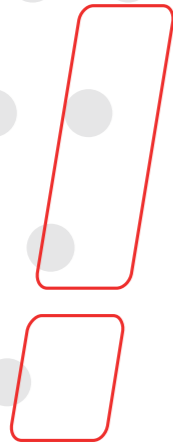

ROCKSTAR
ENERGY
HUSQVARNA
FACTORY
RACING



**BILLY BOLT HARD ENDURO
WORLD CHAMPION**



• 2CP092_



SCAN TO SEE APPLICATION LIST



• DTC COLOR AVAILABLE:



• Aluminum 5mm • 2CP074_

Protecções de disco traseiro

//As Protecções de Disco Traseiras, foram desenvolvidas de forma a assegurar protecção extra para a sua mota, prevenindo danos.

//As protecções foram desenhadas para assegurar:

- Protecção Extra
- Limpeza fácil
- Design atraente

//Material:

- Alumínio de 5mm, disponível em IcePolish ou Preto
- DTC de 15mm, disponível em Preto, Vermelho e Laranja.

Rear disc guard

//The CrossPro Rear Disc Guards, were developed in order to assure extra protection to your motorcycle, preventing the damages.

//The protections were designed to assure:

- Extra protection
- Easy cleaning
- Design Awareness

//Material:

- Aluminum 5mm available in Ice Polish Black
- DTC 15mm available in Black, Red and Orange

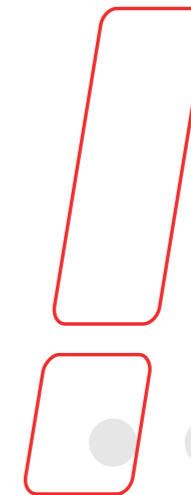

YAMAHA JOHANSSSEN



0.36g 2mm AI Aluminum 2CP0730001****
2 STROKE

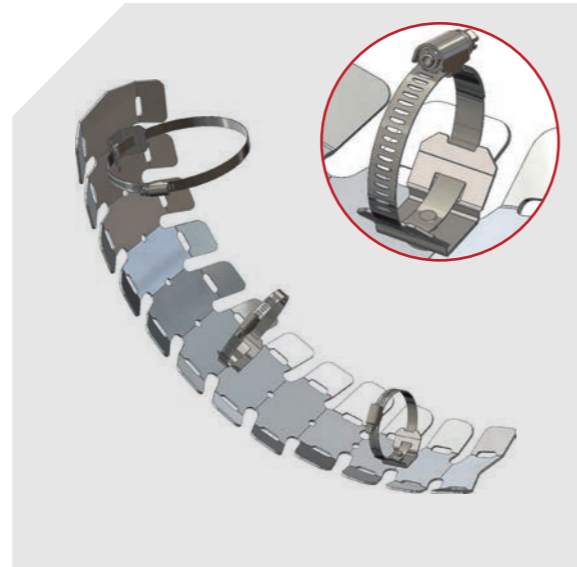

0.40g 2mm AI Aluminum 2CP0730005****
2 STROKE EVO
With clamp "easy fixing"



0.16g 2mm AI Aluminum 2CP0730002****
4 STROKE



0.22g 2mm AI Aluminum 2CP0730003****
4 STROKE
With clamp "easy fixing"



• 2CP073_

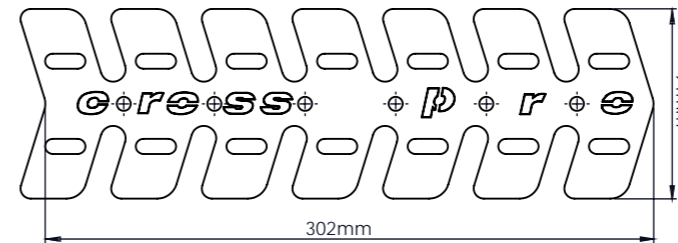

4-STR

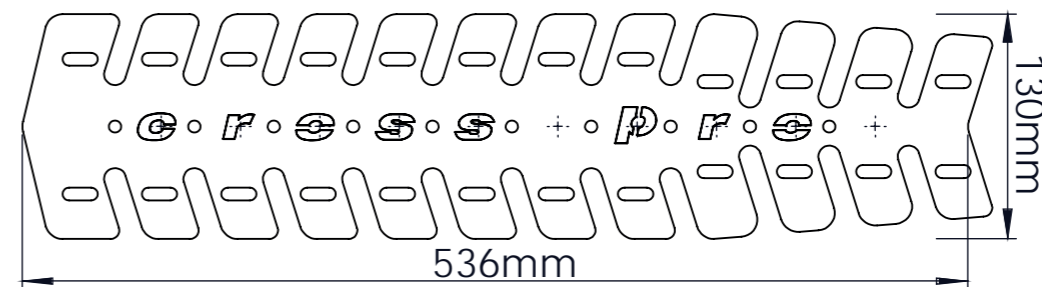

2-STR

ALUMINUM EXHAUST PROTECTION

Available in various colors
See page: 147

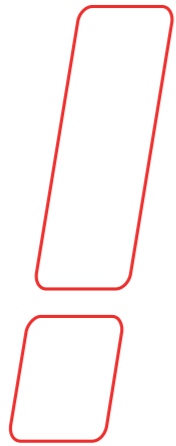

RITA VIEIRA
ENDURO WOMEN
RIDER...





SCAN TO SEE APPLICATION LIST

! CARBON EXHAUST PROTECTION



• 2CP07300040000

! FORK WRENCH

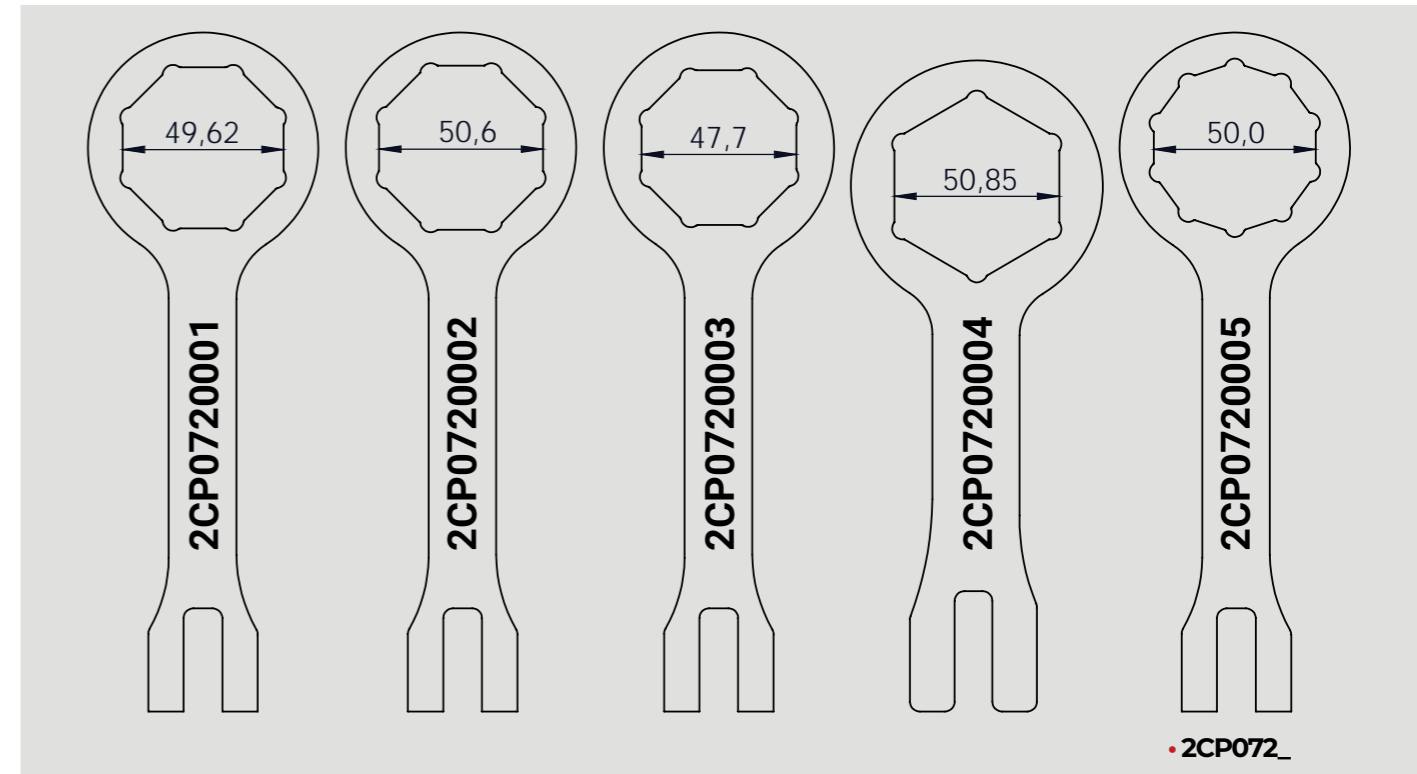

• 2CP072_

! WASTE DISPOSAL

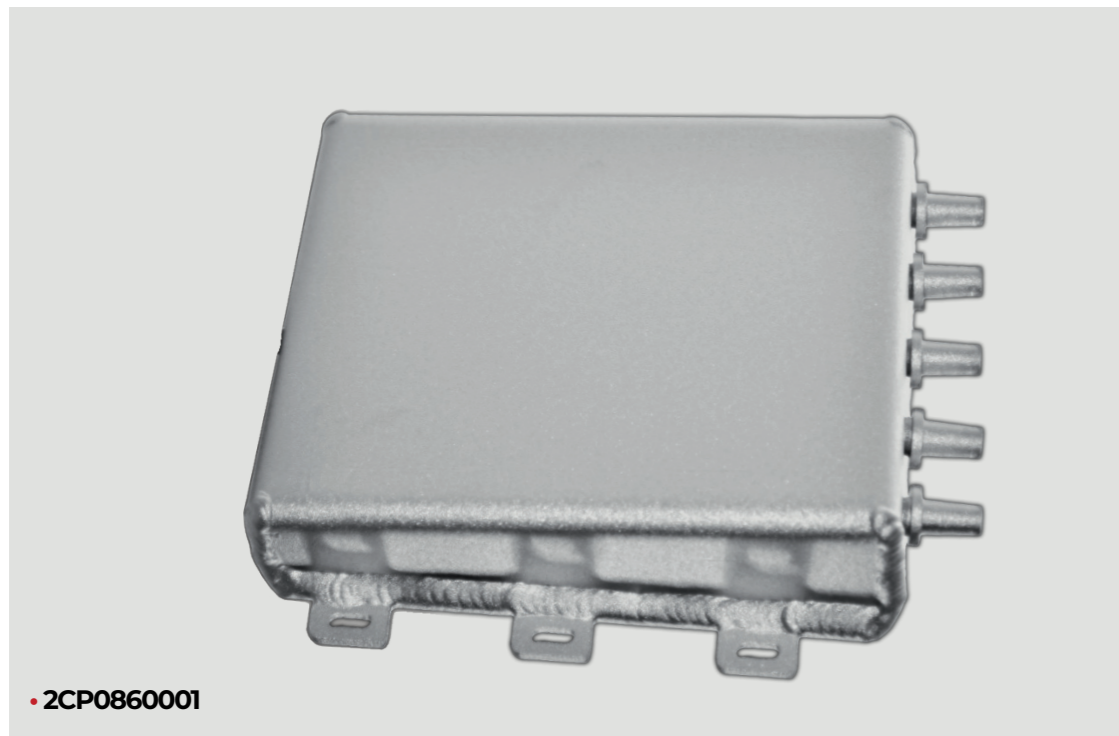

• 2CP0860001

Available in various colors
See page: 147



Available in various colors
See page: 147



JAMIE McCANNEY 2nd in E1 ISDE FRANCE

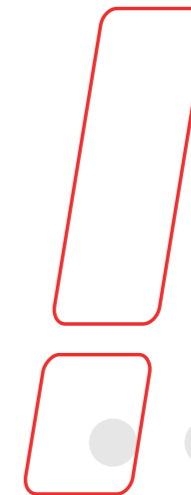

FASTEDDY
RACING



• 2CP08200120004



• 2CP08200120006



• 2CP08200120007



• 2CP08200120008



• 2CP08200120009



• 2CP08200120010



• 2CP08200120011

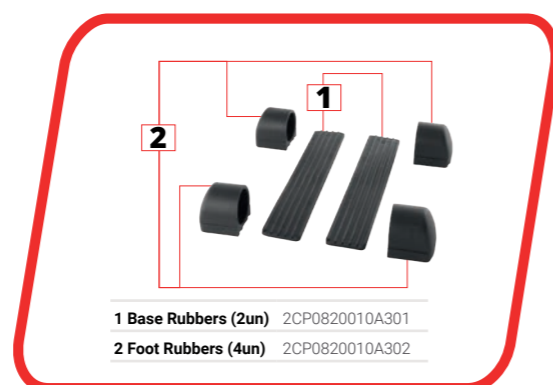

1 Base Rubbers (2un) 2CP0820010A301
2 Foot Rubbers (4un) 2CP0820010A302

BIKE STAND HARD XTREME 2.0

Available in various colors
See page: 147



• 2CP082_

- Weight / peso: 7,04kg
- Minimum height / altura mínima: 31cm
- Maximum height / altura máxima: 40cm
- Maximum weight / peso máximo: 210kg

Cavalete HARD XTREME 2.0

- »Construído em aço carbono extremamente resistente
- »Bases reforçadas para maior estabilidade
- »Parte superior e pés em borracha antiderrapante substituíveis.
- »Sistema de elevação otimizado
- » Acabamento em pintura eletrostática para maior durabilidade
- »Design inovador.

HARD XTREME 2.0 Bike lift

- »Made of extremely durable carbon steel
- »Reinforced bases for better stability
- »Replaceable non-slip rubber upper and feet.
- »Optimized Lifting System
- »Electrostatic paint finish for durability
- »Innovative design.



• 2CP08200100005



• 2CP08200100006



• 2CP08200100007



• 2CP08200100008



• 2CP08200100009



• 2CP08200100010



• 2CP08200100011

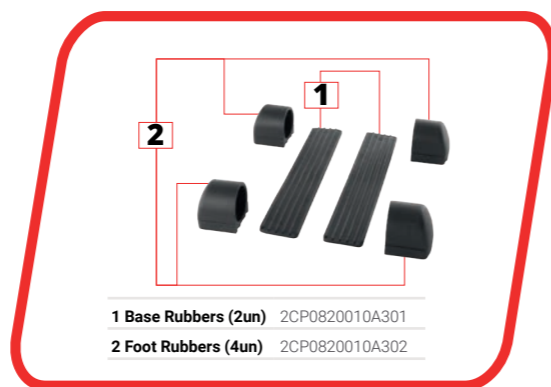

BIKE STAND XTREME 16



Cavaletes em ferro

- »Fabricado em aço com proteção superior em borracha anti-derrapante.
- »Topos anti-derrapante.
- »Sistema de elevação com desmultiplicação de esforço.
- »Design inovador.

- » Weight / peso: 5,50kg
- » Minimum height / altura mínima: 30cm
- » Maximum height / altura máxima: 40cm
- » Maximum weight / peso máximo: 140kg

Iron bike stand

- »Made of steel with Anti-slip rubber protection on the top
- »Anti-slip top
- »Lifting system with less effort
- »Innovative design



BIKE STAND

GRAND PRIX HARD

Available in various colors
See page: 147



Cavaletes em alumínio

- » Novo Design em diferentes cores
- » Mais resistente
- » Orifício para mudança de óleo
- » Mais Económico

Aluminum bike stand

- » New Design in different Colors
- » More resistant
- » Hole for Oil Change
- » More Economic

• 2CP082_



• 2CP08200T10001 • 2CP08200T10004 • 2CP08200T10005 • 2CP08200T10006 • 2CP08200T10007



• 2CP08200T10008 • 2CP08200T10009 • 2CP08200T10010 • 2CP08200T10011

FOLDING BIKE RAMP



Sofia Porfirio



• 2CP083_

Available in various colors
See page: 147

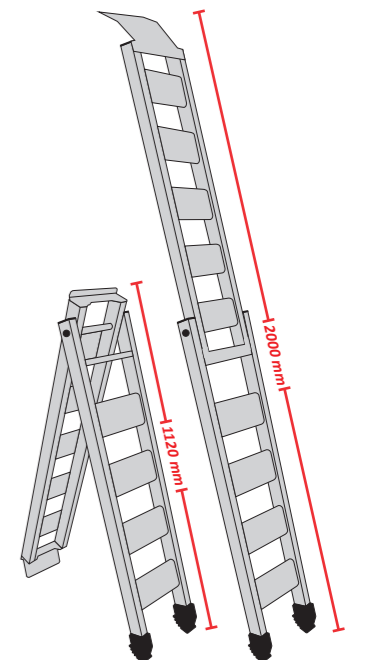

-Supported weight: 240kg
-Peso suportado: 240kg



- Ice Matte folding bike ramp
- Black folding bike ramp
- White folding bike ramp
- Red folding bike ramp
- Yellow folding bike ramp
- Green folding bike ramp
- Orange folding bike ramp
- Blue folding bike ramp

- 2CP083001A0001
- 2CP083001A0004
- 2CP083001A0006
- 2CP083001A0007
- 2CP083001A0008
- 2CP083001A0009
- 2CP083001A0010
- 2CP083001A0011

» **Protege o mais importante com Crosspro**

A CrossPro oferece uma vasta gama de protecções em alumínio e DTC, da mais elevada qualidade, para proteger a sua moto.

Acessórios como Pára-choques, Nerf Bars e Protecções de chassis constituem o conjunto perfeito para a prática de Todo-o-terreno.

Desenvolvidas com recurso às melhores matérias-primas e com suporte das melhores técnicas de produção, as protecções CrossPro são uma peça fundamental para usufruir ao máximo da sua moto.

Ride and enjoy it

» **Protect the important with CrossPro**

The CrossPro offer you a wide range of aluminum and DTC protections, with highest quality, to protect your bike.

Accessories such as Bumpers, Nerf Bars and Chassis Protectors are the perfect set for the practice of all-terrain. Developed using the best raw materials and with support of improved production techniques, the CrossPro protections are essential to enjoy the most with your bike.

Ride and enjoy it



SPORTS QUAD
RACING
PROTECTION

RAFAEL CARVALHO

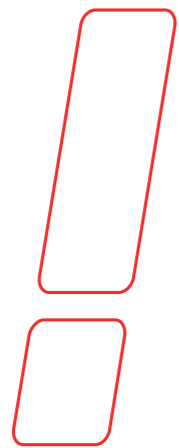

FRONT BUMPERS



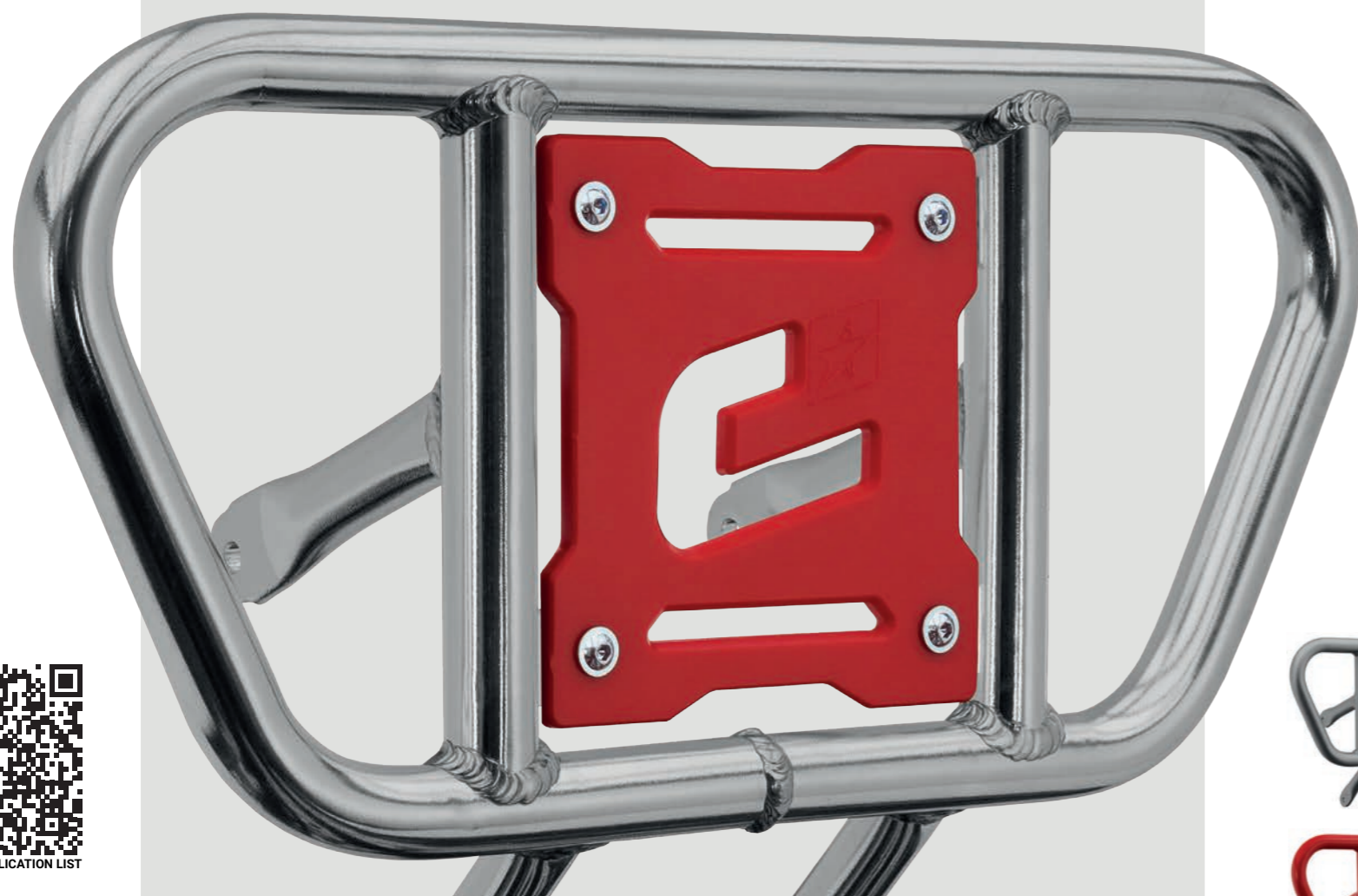

SCAN TO SEE APPLICATION LIST

FRONT BUMPER CR01

• 2CP229A_ (front tube)



• 2CP229A_0001



• 2CP229A_0002



• 2CP229A_0004



• 2CP229A_0005



• 2CP229A_0006



• 2CP229A_0007



• 2CP229A_0008



• 2CP229A_0009



• 2CP229A_0010



• 2CP229A_0011

60



COMBINABLE COLORS
COMBINAÇÕES DE CORES

• 2CP229_ (Complete front bumper)



• 2CP229A0000_ (Universal front plate)



• 2CP229A0000300



• 2CP229A0000400



• 2CP229A0000500



• 2CP229A0000600



• 2CP229A0000700



• 2CP229A0000900

O pára-choques frontal CROSSPRO CR01 dá nas vistas com o seu design inovador e arrojado e é diferente de tudo alguma vez visto. Fabricado em alumínio de alta qualidade e com recurso a processos automatizados de corte tubo a laser, maquinaria e curvatura em CNC. O seu visual, com uma leve placa frontal em DTC da melhor qualidade, aliado a 60 combinações diferentes de cores (entre a parte tubular e a placa frontal) está bem integrado ao projeto QUAD. Sem vibrações.

Composição:

- Alumínio alta resistência
- Tubo Ø 25 x 3mm
- Placa Frontal DTC 6mm
- Dimensões Máximas: 44cm x 21cm
- Pontos fixação: 4
- Kit montagem incluído, montagem fácil sem necessidade de qualquer modificação.

The CROSSPRO CR01 front bumper stands out with its bold and innovative design, unlike anything ever seen. Manufactured in high quality aluminum and using automated processes of laser tube cutting, CNC machining and bending. Its look, with a light front plate in the best quality DTC, combined with 60 different color combinations (between the tubular part and the front plate) is well integrated into the QUAD design. No vibrations.

Composition:

- High Strength Aluminum
- Tube Ø 25 x 3mm
- Front Plate DTC 6mm
- Maximum Dimensions: 44cm x 21cm
- Attachment points: 4
- Mounting kit included, easy assembly without any modification required.

FRONT BUMPER

CRO2



O pára-choques frontal CROSSPRO CR02 dá nas vistas com o seu design inovador e arrojado e é diferente de tudo alguma vez visto. Fabricado em alumínio de alta qualidade e com recurso a processos automatizados de corte tubo a laser, maquinação e curvatura em CNC. O seu visual, com uma leve placa frontal em DTC da melhor qualidade, aliado a 60 combinações diferentes de cores (entre a parte tubular e a placa frontal) está bem integrado ao projeto QUAD. Sem vibrações.

The CROSSPRO CR02 front bumper stands out with its bold and innovative design, unlike anything ever seen. Manufactured in high quality aluminum and using automated processes of laser tube cutting, CNC machining and bending. Its look, with a light front plate in the best quality DTC, combined with 60 different color combinations (between the tubular part and the front plate) is well integrated into the QUAD design. No vibrations.

- Composição:
- Alumínio alta resistência
 - Tubo Ø 25 x 3mm
 - Placa Frontal DTC 6mm
 - Dimensões Máximas: 46cm x 22cm
 - Pontos fixação: 4
 - Kit montagem incluído, montagem fácil sem necessidade de qualquer modificação.

- Composition:
- High Strength Aluminum
 - Tube Ø 25 x 3mm
 - Front Plate DTC 6mm
 - Maximum Dimensions: 46cm x 22cm
 - Attachment points: 4
 - Mounting kit included, easy assembly without any modification required.



•2CP230_ (Complete front bumper)

•2CP230A_ (front tube)



•2CP230A__0001 •2CP230A__0002 •2CP230A__0004 •2CP230A__0005 •2CP230A__0006
 •2CP230A__0007 •2CP230A__0008 •2CP230A__0009 •2CP230A__0010 •2CP230A__0011



60

COMBINABLE COLORS
COMBINAÇÕES DE CORES

•2CP229A0000_ (Universal front plate)

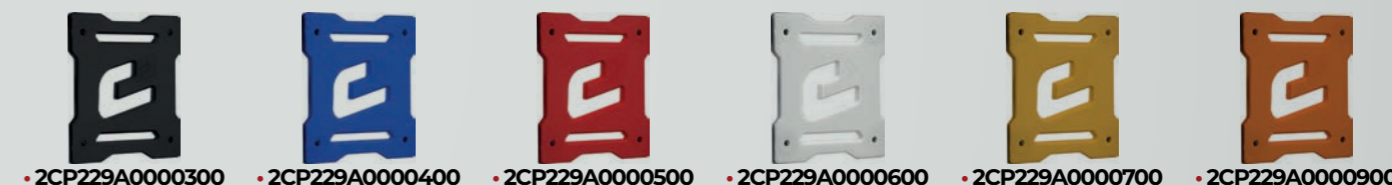

•2CP229A0000300 •2CP229A0000400 •2CP229A0000500 •2CP229A0000600 •2CP229A0000700 •2CP229A0000900



60

COMBINABLE COLORS COMBINAÇÕES DE CORES

FRONT BUMPER CR03



• **2CP231_** (Complete front bumper)



• **2CP231A0000_** (Universal front plate)



• **2CP231A_** (front tube)



O pára-choques frontal CROSSPRO CR03 dá nas vistas com o seu design inovador e arrojado e é diferente de tudo alguma vez visto. Fabricado em alumínio de alta qualidade e com recurso a processos automatizados de corte tubo a laser, maquinação e curvatura em CNC. O seu visual, com uma leve placa frontal em DTC da melhor qualidade, aliado a 60 combinações diferentes de cores (entre a parte tubular e a placa frontal) está bem integrado ao projeto QUAD. Sem vibrações.

Composição:
 • Alumínio alta resistência
 • Tubo Ø 25 x 3mm
 • Placa Frontal DTC 6mm
 • Dimensões Máximas: 49cm x 26cm
 • Pontos fixação: 4
 • Kit montagem incluído, montagem fácil sem necessidade de qualquer modificação.

The CROSSPRO CR03 front bumper stands out with its bold and innovative design, unlike anything ever seen. Manufactured in high quality aluminum and using automated processes of laser tube cutting, CNC machining and bending. Its look, with a light front plate in the best quality DTC, combined with 60 different color combinations (between the tubular part and the front plate) is well integrated into the QUAD design. No vibrations.

Composition:
 • High Strength Aluminum
 • Tube Ø 25 x 3mm
 • Front Plate DTC 6mm
 • Maximum Dimensions: 49cm x 26cm
 • Attachment points: 4
 • Mounting kit included, easy assembly without any modification required.



SCAN TO SEE APPLICATION LIST



60
COMBINABLE COLORS
COMBINAÇÕES DE CORES

FRONT BUMPER CR04



O pára-choques frontal CROSSPRO CR04 dá nas vistas com o seu design inovador e arrojado e é diferente de tudo alguma vez visto. Fabricado em alumínio de alta qualidade e com recurso a processos automatizados de corte tubo a laser, maquinação e curvatura em CNC. O seu visual, com uma leve placa frontal em DTC da melhor qualidade, aliado a 60 combinações diferentes de cores (entre a parte tubular e a placa frontal) está bem integrado ao projeto QUAD. Sem vibrações.

- Composição:
- Alumínio alta resistência
 - Tubo Ø 25 x 3mm
 - Placa Frontal DTC 6mm
 - Dimensões Máximas: 51cm x 29cm
 - Pontos fixação: 4
 - Kit montagem incluído, montagem fácil sem necessidade de qualquer modificação.

The CROSSPRO CR04 front bumper stands out with its bold and innovative design, unlike anything ever seen. Manufactured in high quality aluminum and using automated processes of laser tube cutting, CNC machining and bending. Its look, with a light front plate in the best quality DTC, combined with 60 different color combinations (between the tubular part and the front plate) is well integrated into the QUAD design. No vibrations.

- Composition:
- High Strength Aluminum
 - Tube Ø 25 x 3mm
 - Front Plate DTC 6mm
 - Maximum Dimensions: 51cm x 29cm
 - Attachment points: 4
 - Mounting kit included, easy assembly without any modification required.



• 2CP232A0000_ (Universal front plate)



FRONT BUMPER P-SERIES

- »Design Standard
- »Extremamente Leve
- »Placa Frontal Ventilada
- »Máxima Protecção
- »Tubo de alumínio de elevada resistência (T6061) - 35mm
- »Soldado a TIG para extra durabilidade
- »Testado em competição
- »Para-Choques Perfeito para QX

- »Standard Design
- »Extremely light
- »Vented Frontal Plate
- »Maximum protection
- »Strong aluminum tubing (T6061) - 35mm
- »Tig welded for extra strength
- »Race tested and proved
- »Perfect for MX Racing

» Replace the ("") for the code of the desired color Example: Red Color 2CP01600010007

» Substituir os ("") pelo código de cor pretendida:Exemplo: para a cor vermelha 2CP01600010007

● »0001	● »0002	● »0004	● »0005	○ »0006	● »0007	● »0008	● »0009	● »0010	● »0011
Ice Matte Ice Polish	Polish Polido	Black Preto	Textured Black Preto Texturado	White Branco	Red Vermelho	Yellow Amarelo	Green Verde	Orange Laranja	Blue Azul



P21
•2CP016_

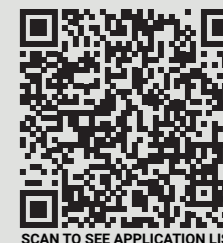

SCAN TO SEE APPLICATION LIST



P25
•2CP017_



P30
•2CP018_



P35
•2CP019_

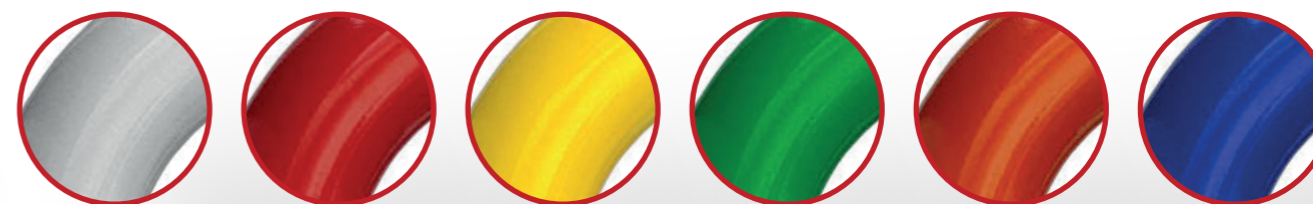
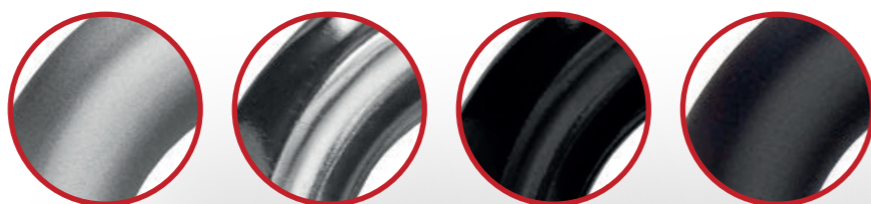

FRONT BUMPER

WASPE LITE



- »Design Atraente e Inovador
- »Pára-Choques perfeito para competição ou lazer
- »Soldado com tecnologia TIG
- »Leveza e Máxima Resistência
- »BAS (Bumper Adjustment System) – novo sistema de fixação que permite o ajuste em altura e em inclinação do Pára-Choques
- »Sistema testado em competição
- »Fácil Montagem
- »Elevada resistência ao Impacto

- »Innovative design
- »Perfect Bumper for Racing or Recreation
- »All Precision TIG Welded
- »Light weight and Maximum Resistance
- »BAS (Bumpers Adjustment System), a new fitting system that allows the adjustment in depth, height and frontal angle of each Bumper
- »System tested in competition
- »Easy to mount
- »High resistance to impact

• **2CP037_** (Specific fixation)



60 COMBINABLE COLORS
COMBINAÇÕES DE CORES



• **2CP028_** (Universal front tube)



• **2CP033_** (Universal front plate)



Available in various colors
See page: 147



SCAN TO SEE APPLICATION LIST



• 2CP024_ (Complete front bumper)



60



COMBINABLE COLORS
COMBINAÇÕES DE CORES

FRONT BUMPER WASPE



• 2CP028_ (Universal front tube)



- 2CP0280000001
- 2CP0280000002
- 2CP0280000004
- 2CP0280000005
- 2CP0280000006
- 2CP0280000007
- 2CP0280000008
- 2CP0280000009
- 2CP0280000010
- 2CP0280000011

• 2CP037_ (Specific fixation)

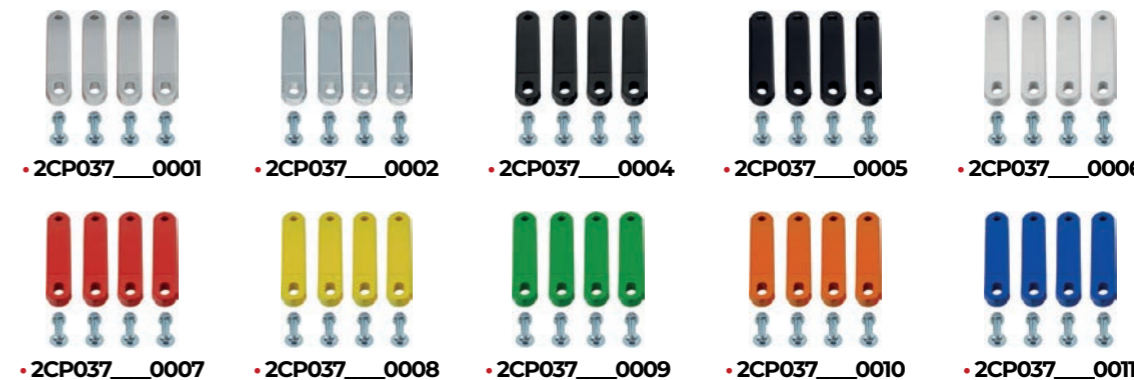

- 2CP037_0001
- 2CP037_0002
- 2CP037_0004
- 2CP037_0005
- 2CP037_0006
- 2CP037_0007
- 2CP037_0008
- 2CP037_0009
- 2CP037_0010
- 2CP037_0011

• 2CP034_ (Universal front plate)



- 2CP03400000300
- 2CP03400000400
- 2CP03400000500
- 2CP03400000600
- 2CP03400000700
- 2CP03400000900

- »Design Atraente e Inovador
- »Pára-Choques perfeito para competição ou lazer
- »Soldado com tecnologia TIG
- »Leveza e Máxima Resistência
- »BAS (Bumper Adjustment System) – novo sistema de fixação que permite o ajuste em altura e em inclinação do Pára-Choques
- »Sistema testado em competição
- »Fácil Montagem
- »Elevada resistência ao Impacto

- »Innovative design
- »Perfect Bumper for Racing or Recreation
- »All Precision TIG Welded
- »Light weight and Maximum Resistance
- »BAS (Bumpers Adjustment System), a new fitting system that allows the adjustment in depth, height and frontal angle of each Bumper
- »System tested in competition
- »Easy to mount
- »High resistance to impact

FRONT BUMPER GLIESE



SCAN TO SEE APPLICATION LIST

• 2CP022_ (Complete front bumper)



Available in various colors
See page: 147

60
COMBINABLE COLORS
COMBINAÇÕES DE CORES

• 2CP037_ (Specific fixation)



• 2CP027_ (Universal front tube)



• 2CP032_ (Universal front plate)





- »Design Atraente e Inovador
- »Pára-Choques perfeito para competição ou lazer
- »Soldado com tecnologia TIG
- »Leveza e Máxima Resistência
- »BAS (Bumper Adjustment System) - novo sistema de fixação que permite o ajuste em altura e em inclinação do Pára-Choques
- »Sistema testado em competição
- »Fácil Montagem
- »Elevada resistência ao Impacto

- »Innovative design
- »Perfect Bumper for Racing or Recreation
- »All Precision TIG Welded
- »Light weight and Maximum Resistance
- »BAS (Bumpers Adjustment System), a new fitting system that allows the adjustment in depth, height and frontal angle of each Bumper
- »System tested in competition
- »Easy to mount
- »High resistance to impact

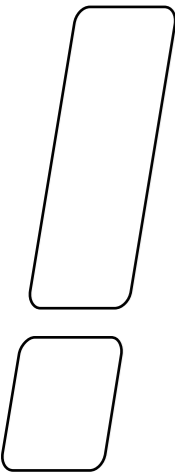

FRONT BUMPER HAT

- »Design Atraente e Inovador
- »Pára-Choques perfeito para competição ou lazer
- »Soldado com tecnologia TIG
- »Leveza e Máxima Resistência
- »BAS (Bumper Adjustment System) - novo sistema de fixação que permite o ajuste em altura e em inclinação do Pára-Choques
- »Sistema testado em competição
- »Fácil Montagem
- »Elevada resistência ao Impacto

- »Innovative design
- »Perfect Bumper for Racing or Recreation
- »All Precision TIG Welded
- »Light weight and Maximum Resistance
- »BAS (Bumpers Adjustment System), a new fitting system that allows the adjustment in depth, height and frontal angle of each Bumper
- »System tested in competition
- »Easy to mount
- »High resistance to impact

60 COMBINABLE COLORS
COMBINAÇÕES DE CORES

• 2CP037_ (Specific fixation)



• 2CP030_ (Universal front tube)



• 2CP035_ (Universal front plate)

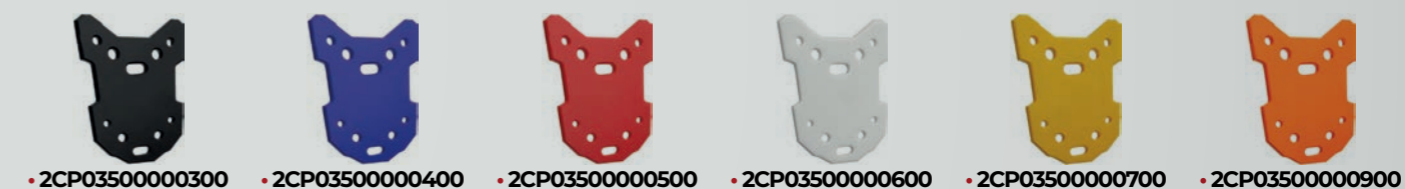

Available in various colors
See page: 147

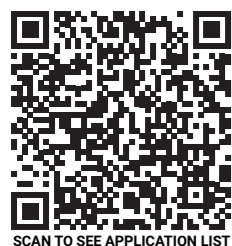

SCAN TO SEE APPLICATION LIST

FRONT BUMPER COROT



• 2CP031_ (Universal front tube)



• 2CP026_ (Complete front bumper)



60

COMBINABLE COLORS
COMBINAÇÕES DE CORES



• 2CP037_ (Specific fixation)



• 2CP033_ (Universal front plate)



- » Design Atraente e Inovador
- » Para-Choques perfeito para competição ou lazer
- » Soldado com tecnologia TIG
- » Leveza e Máxima Resistência
- » BAS (Bumper Adjustment System) – novo sistema de fixação que permite o ajuste em altura e em inclinação do Para-Choques
- » Sistema testado em competição
- » Fácil Montagem
- » Elevada resistência ao Impacto

- » Innovative design
- » Perfect Bumper for Racing or Recreation
- » All Precision TIG Welded
- » Light weight and Maximum Resistance
- » BAS (Bumpers Adjustment System), a new fitting system that allows the adjustment in depth, height and frontal angle of each Bumper
- » System tested in competition
- » Easy to mount
- » High resistance to impact

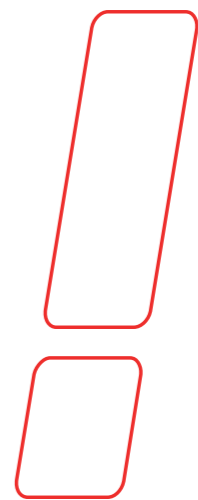

NERF-BARS

ride and ENJOY IT

NEW



SCAN TO SEE APPLICATION LIST

NERF-BAR

HARD RACING 2.0

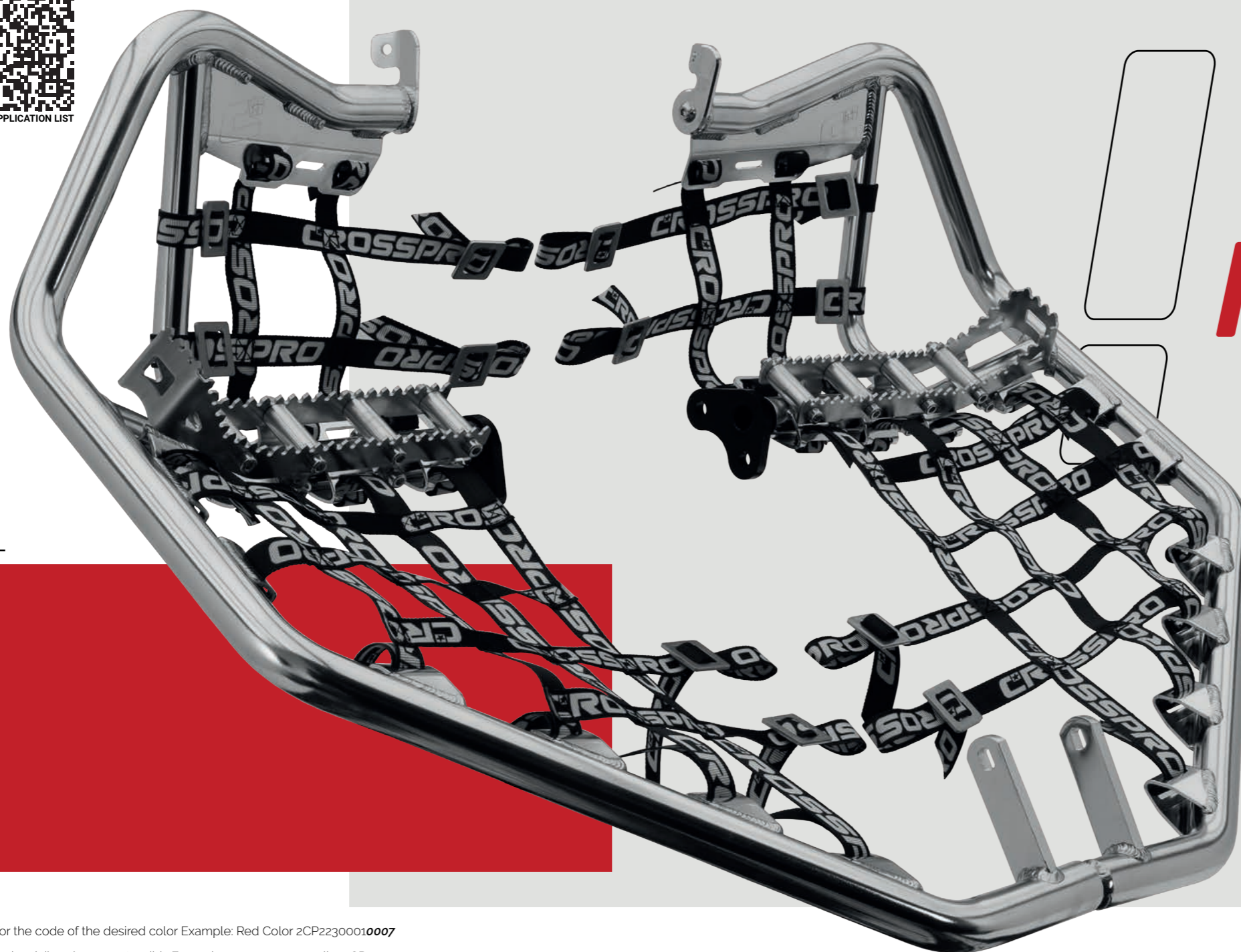

•2CP223_

Composição: Alumínio Liga 6061, Inox 304
Características Técnicas:
Tubo Ø 35 mm
Estribos em Inox 304 com 3 mm de espessura

Uma nova geometria permitiu baixar em cerca de 15 mm o Nerf Bar em relação aos outros modelos Crosspro.
Estribos c/ 3 inclinações possíveis removíveis e de fácil substituição.
Baixo Peso, Ultra resistente
Usado por profissionais alta competição

Composition: Aluminum Alloy 6061, Stainless Steel 304
Technical Features:
Tube Ø 35 mm
304 stainless foot pegs, 3 mm thick

A new geometry made it possible to lower the Nerf Bar by about 15 mm compared to other Crosspro models.
Foot Pegs with 3 possible inclinations, removable and easy to replace.
Light Weight, Ultra Durable
Used by high competition professionals

» Replace the (****) for the code of the desired color Example: Red Color 2CP22300010007

» Substituir os (****) pelo código de cor pretendida: Exemplo: para a cor vermelha 2CP22300010007

- »0001
Ice Matte
Ice Polish
- »0002
Polish
Polido
- »0004
Black
Preto
- »0005
Textured Black
Preto
Texturado
- »0006
White
Branco
- »0007
Red
Vermelho
- »0008
Yellow
Amarelo
- »0009
Green
Verde
- »0010
Orange
Laranja
- »0011
Blue
Azul



See page: 147

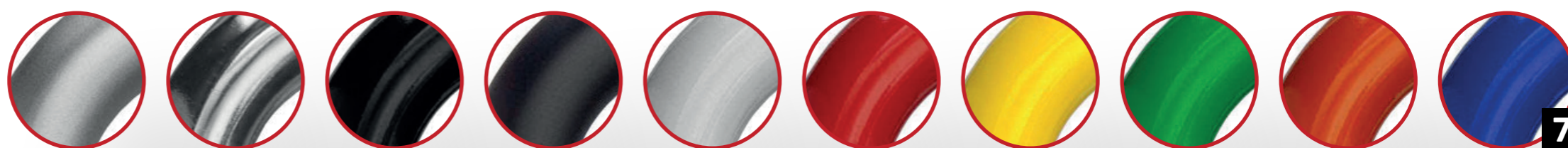



HARD RACING NERF-BAR

• 2CP135_

Available in various colors
See page: 147



- »Tubo de alumínio de elevada resistência (T6061) – 35mm
- »Soldado a TIG para extra durabilidade
- »Perfeito para Lazer ou competição

- »Aluminum tube (T6061)- 35mm for high resistance
- »TIG welded for extra strength
- »Perfect for recreation or competition

- » Replace the (****) for the code of the desired color Example: Red Color 2CP13500010007
- » Substituir os (****) pelo código de cor pretendida:Exemplo: para a cor vermelha 2CP13500010007

»0001	»0002	»0004	»0005	»0006	»0007	»0008	»0009	»0010	»0011
Ice Matte	Polish	Black	Textured Black	White	Red	Yellow	Green	Orange	Blue
Ice Polish	Polido	Preto	Preto Texturado	Branco	Vermelho	Amarelo	Verde	Laranja	Azul

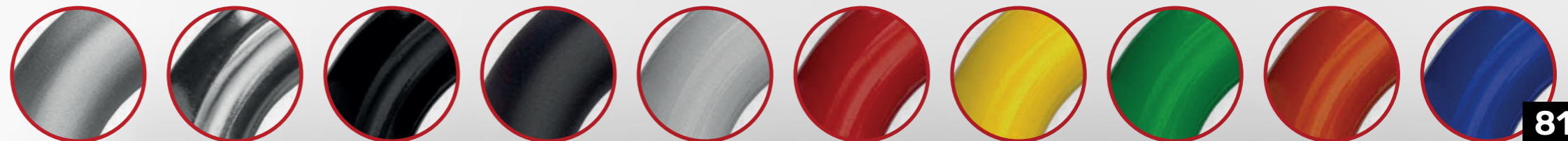

NERF-BAR RACING PRO

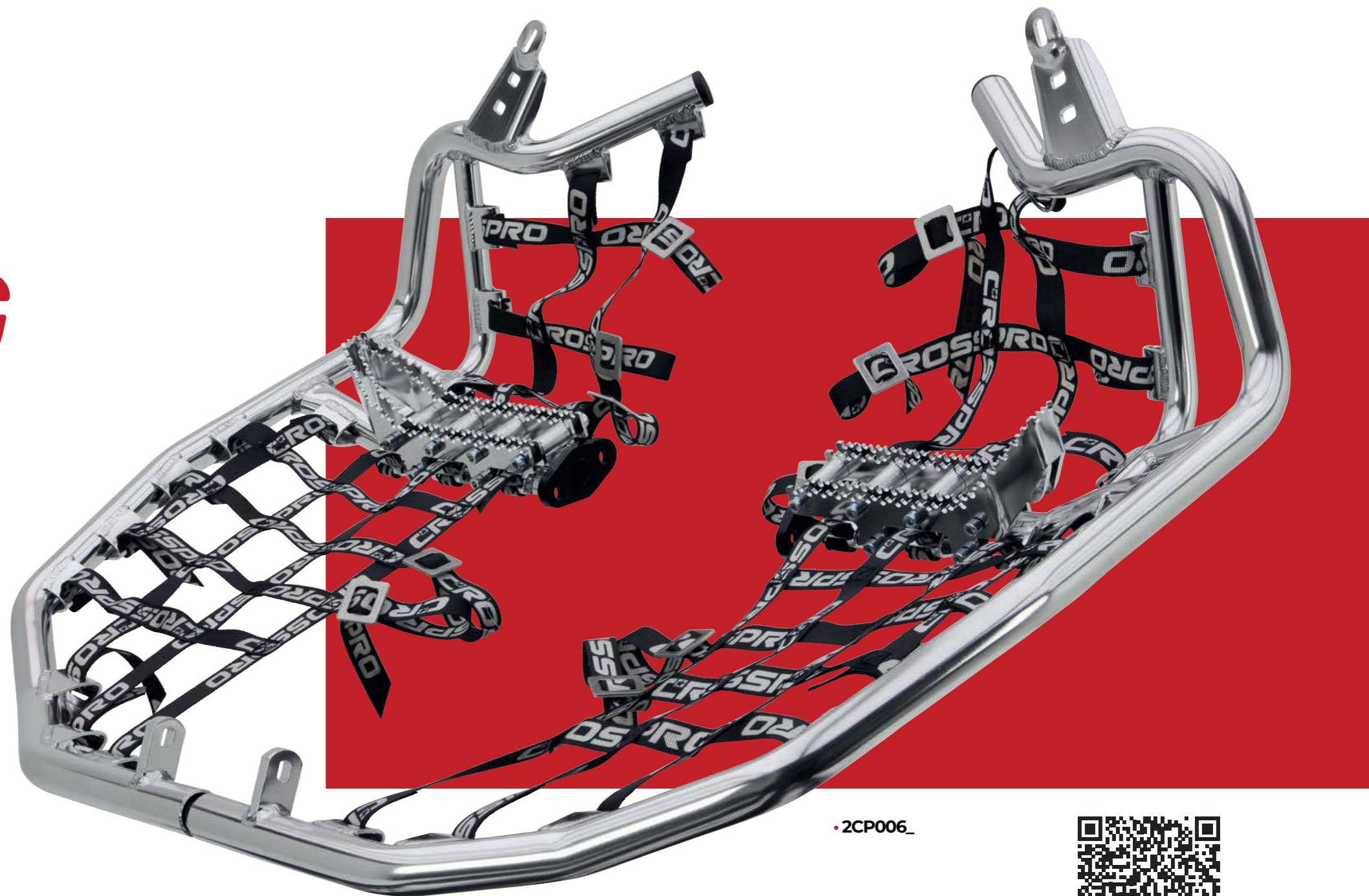

»Tubo de alumínio de elevada resistência (T6061) – 35mm
 »Soldado a TIG para extra durabilidade
 »Perfeito para Lazer ou competição

»Aluminum tube (T6061)- 35mm for high resistance
 »TIG welded for extra strength
 »Perfect for recreation or competition

•2CP006_



SCAN TO SEE APPLICATION LIST

» Replace the (****) for the code of the desired color Example: Red Color 2CP0060001:0007

» Substituir os (****) pelo código de cor pretendida:Exemplo: para a cor vermelha 2CP0060001:0007

● »0001	● »0002	● »0004	● »0005	● »0006	● »0007	● »0008	● »0009	● »0010	● »0011
Ice Matte Ice Polish	Polish Polido	Black Preto	Textured Black Preto Texturado	White Branco	Red Vermelho	Yellow Amarelo	Green Verde	Orange Laranja	Blue Azul

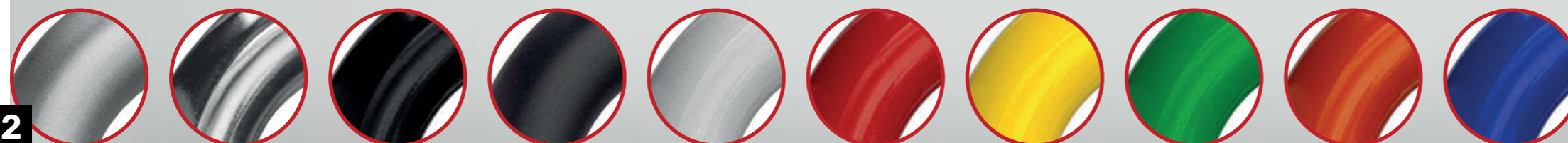

Available in various colors
 See page: 147

NERF-BAR

ECO PRO

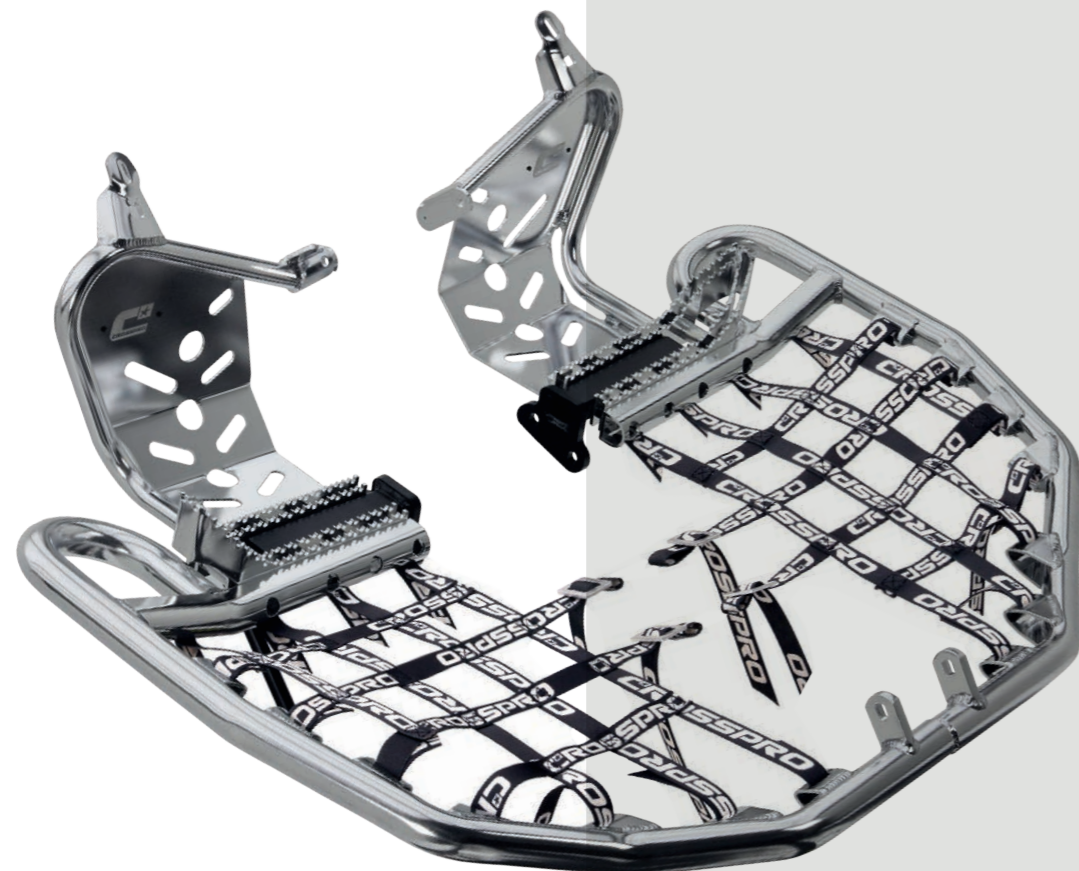

• 2CP005_

»Tubo de alumínio de elevada resistência (T6061) - 35mm
 »Soldado a TIG para extra durabilidade
 »Perfeito para Lazer ou competição

»Aluminum tube (T6061)- 35mm for high resistance
 »TIG welded for extra strength
 »Perfect for recreation or competition



SCAN TO SEE APPLICATION LIST

NERF-BAR EVO PRO



• 2CP004_

» Replace the (****) for the code of the desired color Example: Red Color 2CP00500010007

» Substituir os (****) pelo código de cor pretendida:Exemplo: para a cor vermelha 2CP00500010007

- | | | | | | | | | | |
|-------------------------|------------------|----------------|---|-----------------|-----------------|-------------------|----------------|-------------------|--------------|
| ● »0001 | ● »0002 | ● »0004 | ● »0005 | ● »0006 | ● »0007 | ● »0008 | ● »0009 | ● »0010 | ● »0011 |
| Ice Matte
Ice Polish | Polish
Polido | Black
Preto | Textured
Black
Preto
Texturado | White
Branco | Red
Vermelho | Yellow
Amarelo | Green
Verde | Orange
Laranja | Blue
Azul |

Available in various colors
See page: 147

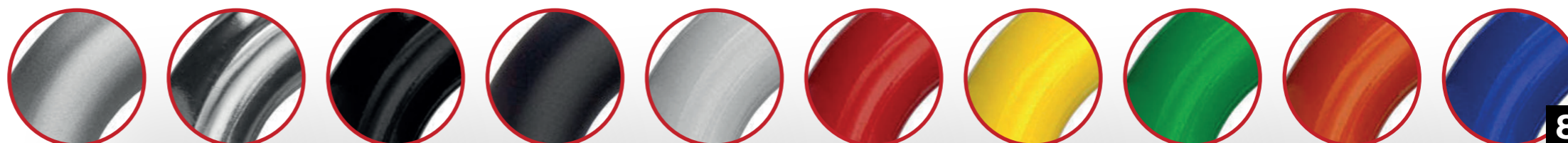

NERF-BARS FIRST STEPS



SCAN TO SEE APPLICATION LIST

EVO1

•2CP002_



»Tubo de alumínio de elevada resistência (T6061) – 35mm
 »Soldado a TIG para extra durabilidade
 »Perfeito para Lazer ou competição

»Aluminum tube (T6061)- 35mm for high resistance
 »TIG welded for extra strength
 »Perfect for recreation or competition

ECOSERIES

•2CP001_

» Replace the (****) for the code of the desired color Example: Red Color 2CP00100010007

» Substituir os (****) pelo código de cor pretendida:Exemplo: para a cor vermelha 2CP00100010007

»0001	»0002	»0004	»0005	»0006	»0007	»0008	»0009	»0010	»0011
Ice Matte Ice Polish	Polish Polido	Black Preto	Textured Black Preto Texturado	White Branco	Red Vermelho	Yellow Amarelo	Green Verde	Orange Laranja	Blue Azul

Available in various colors

 See page: 147

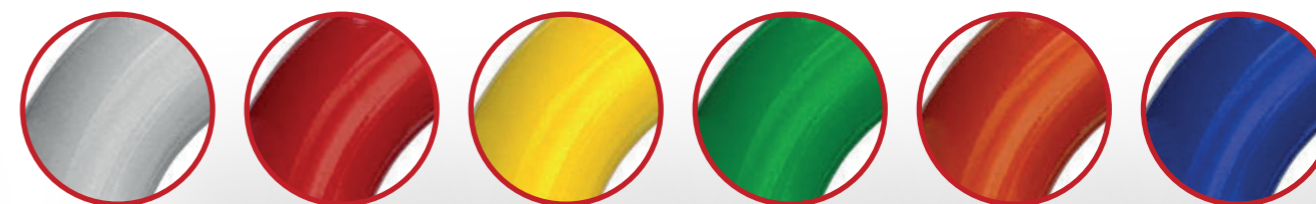
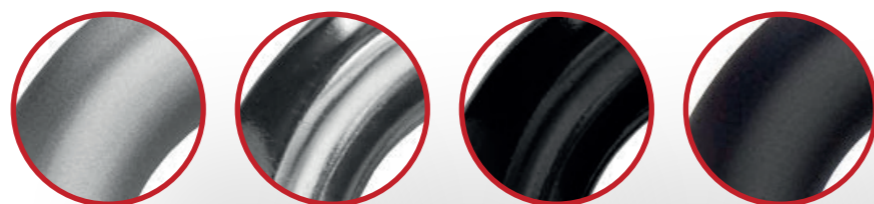

ride and ENJOY IT



FOOT PEGS

•2CP014_



NERF-BARS ACCESSÓRIES

Available in various colors
See page: 147



HEEL PROTECTION

•2CP012_



SCAN TO SEE APPLICATION LIST

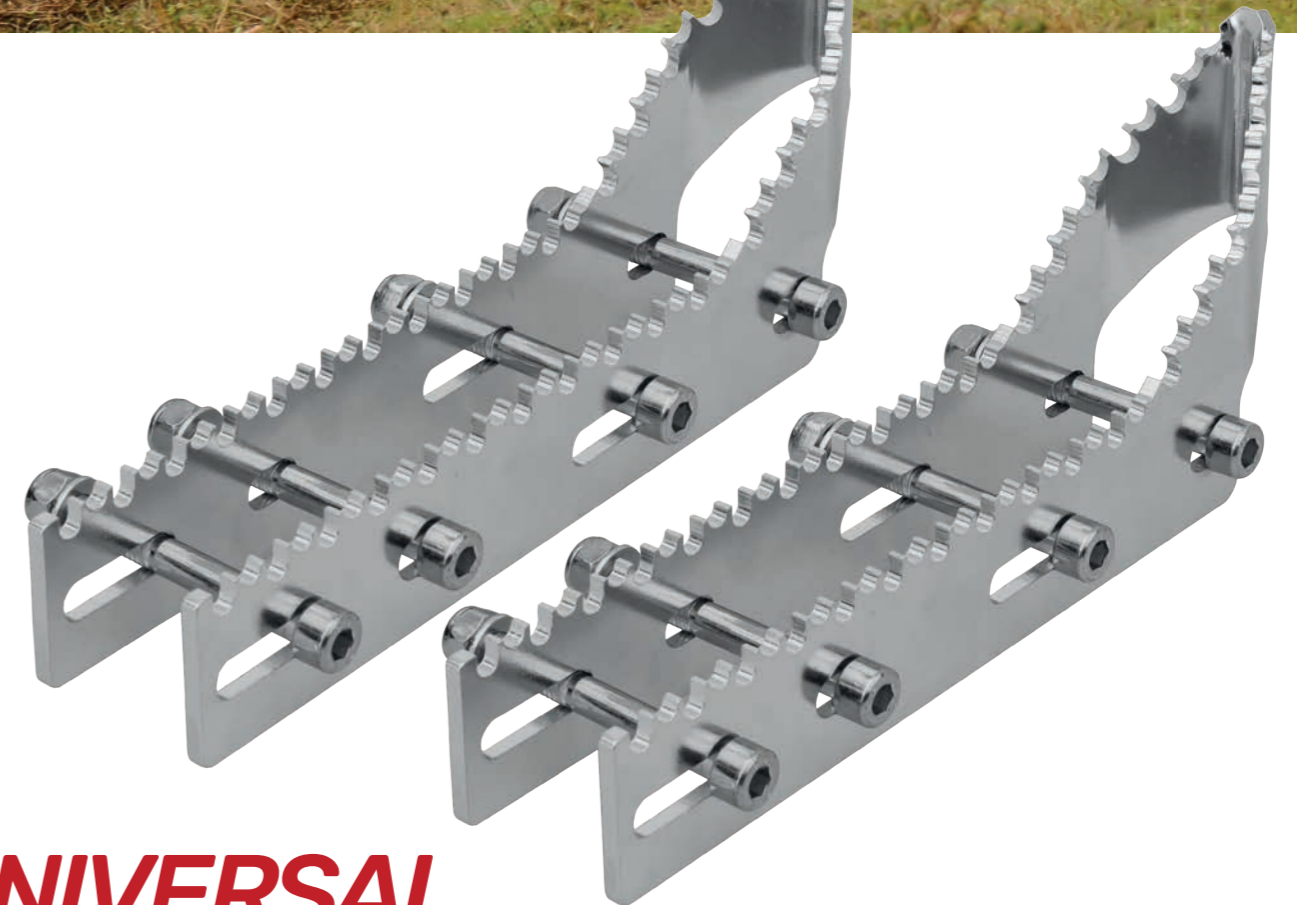

UNIVERSAL FOOT PEGS

•2CP014000000_

Available in various colors
See page: 147

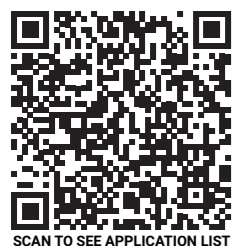

SCAN TO SEE APPLICATION LIST

NERF-BAR BELTS

•2CP14L

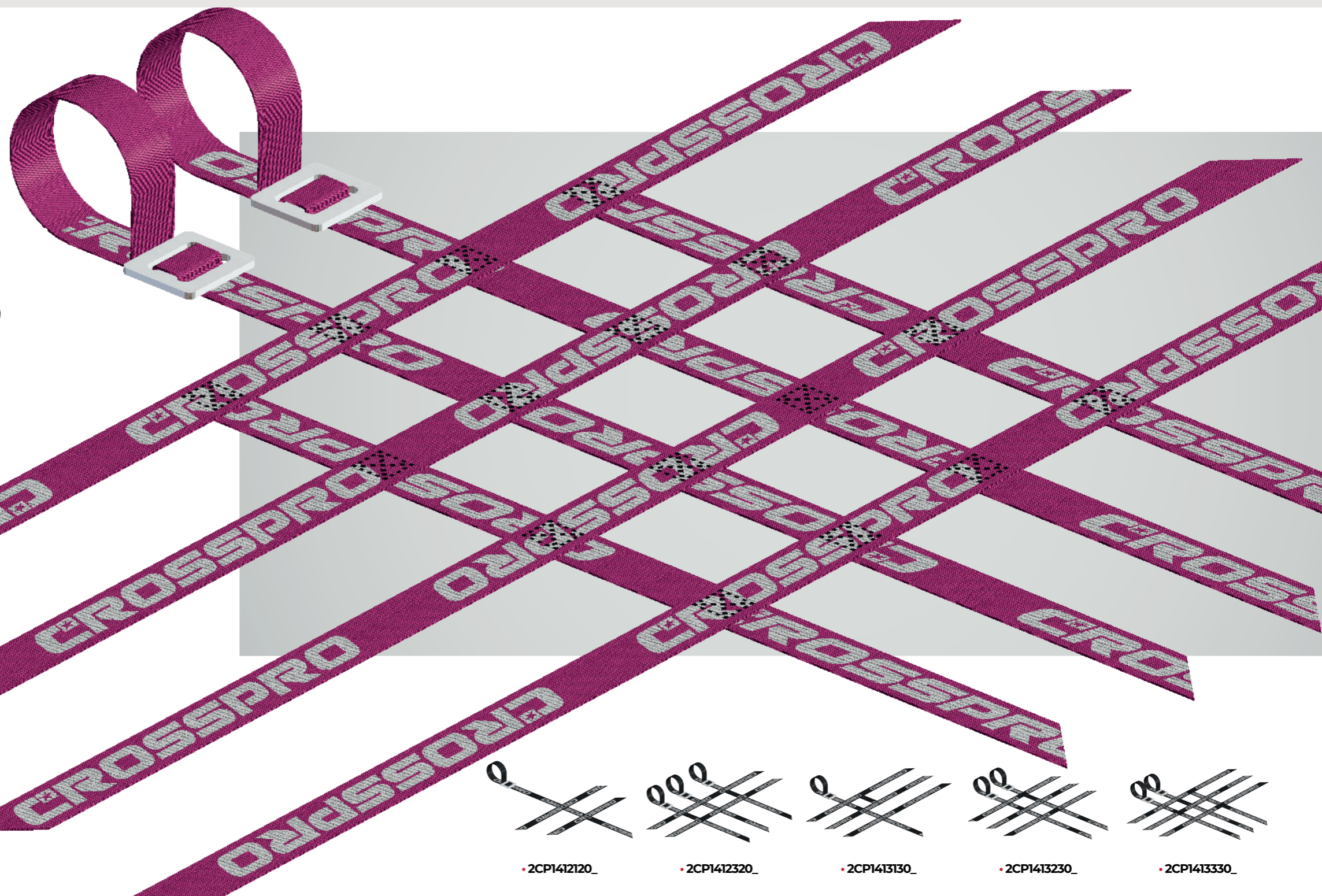

Not Included
Não Incluído

- » Replace the (****) for the code of the desired color Example: Red Color 2CP006000:10007
- » Substituir os (****) pelo código de cor pretendida: Exemplo: para a cor vermelha 2CP006000:10007

- »0004 Black Preto
- »0007 Red Vermelho
- »0008 Yellow Amarelo
- »0009 Green Verde
- »0010 Orange Laranja
- »0011 Blue Azul
- »0011 Pink Rosa



- 2CP1412120_
- 2CP1412320_
- 2CP1413130_
- 2CP1413230_
- 2CP1413330_
- 2CP141333A_
- 2CP1413340_
- 2CP1413440_
- 2CP1414240_
- 2CP141424A_
- 2CP1414340_
- 2CP1414440_
- 2CP10800010000



PROTECTION **QUAD**

- »Produzido com alumínio da mais alta qualidade (T6061), as protecções da CrossPro são fabricada com 4mm de espessura o que combina leveza com a máxima resistência
- »O seu ATV ficará completamente protegido contra o impacto de pedras, paus ou outros objectos que podem causar danos irreversíveis
- »Repuxado na zona de fixação dos parafusos, eliminando quaisquer problemas de fixação

- »Produced in high quality T6061 aluminum, CrossPro protections have 4mm thickness, which combines Lightweight with maximum protection
- »Your atv will be completely protected against rock impacts that can destroy your engine
- »Spun in the fixing screws area, eliminates any fixing problems

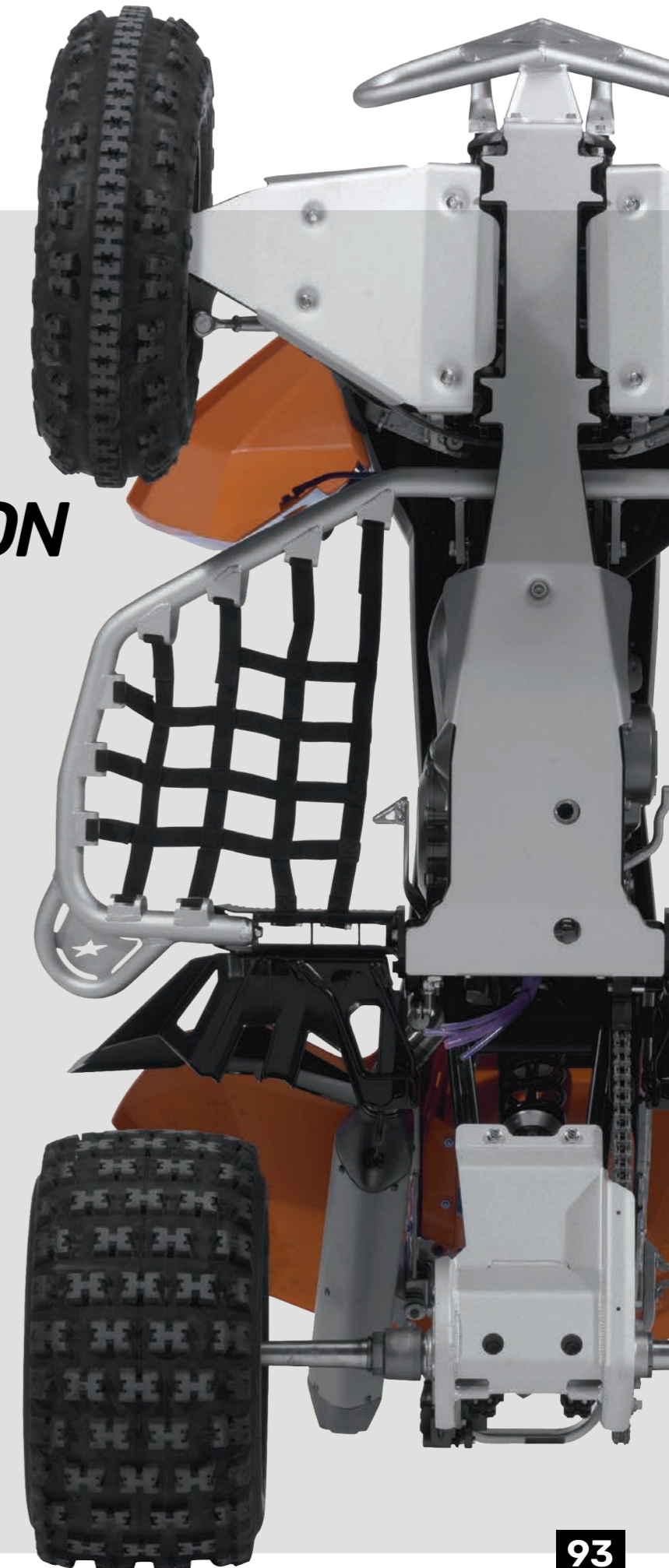

ride and ENJOY IT



DTC TRIANGLE COVERS

- 2CP045_ (Front)
- 2CPT16_ (Rear)



SCAN TO SEE APPLICATION LIST



DTC CARTER COVERS

- 2CP058_ (6mm)
- 2CP096_ (8mm)

DTC

PROTECTION PARTS

Available in 6 or 8mm
Disponível em 6 ou 8mm

» Replace the (****) for the code of the desired color Example: Red Color 2CP04500010500

» Substituir os (****) pelo código de cor pretendida: Exemplo: para a cor vermelha 2CP04500010500

- »0300
- »0400
- »0500
- »0600
- »0700
- »0900

Black
Preto

Blue
Azul

Red
Vermelho

White
Branco

Yellow
Amarelo

Orange
Laranja



- » Conceito Inovador
- » Fabricado em DTC de Alta Densidade de 6mm e 8mm.
- » Não vibra e não provoca ruído
- » Não dobra ou quebra
- » Mais resistente ao risco que o alumínio
- » Metade do peso do alumínio
- » Testado intensivamente por pilotos TOP

- » Innovative concept
- » Manufactured of a high density 6mm and 8mm DTC
- » Does not rattle or vibrate
- » Do not bend or break
- » More scratch resistant than aluminum
- » Half the weight of aluminum
- » Intensely tested by top ATV pilots

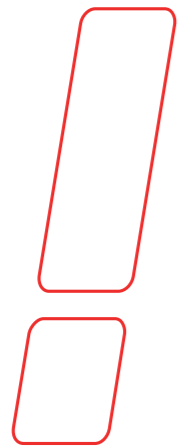

JOÃO VALE













ALUMINUM PROTECTION PARTS

CARTER COVERS
• 2CP040_



» Replace the (****) for the code of the desired color Example: Red Color 2CP00500010007
» Substituir os (****) pelo código de cor pretendida: Exemplo: para a cor vermelha 2CP00500010007

-  »0001
Ice Matte
Ice Polish
-  »0002
Polish
Polido
-  »0004
Black
Preto
-  »0005
Textured Black
Preto
Texturado
-  »0006
White
Branco
-  »0007
Red
Vermelho
-  »0008
Yellow
Amarelo
-  »0009
Green
Verde
-  »0010
Orange
Laranja
-  »0011
Blue
Azul

TRIANGLE COVER
• 2CP038_ (Front)
• 2CP039_ (Rear)



SCAN TO SEE APPLICATION LIST

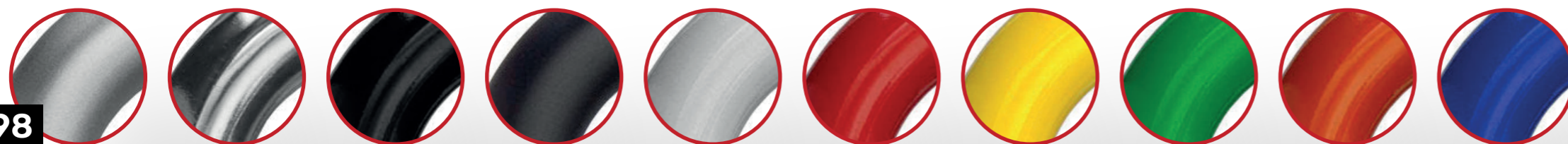

 Available in various colors

See page: 147

ALUMINUM DISC GUARD



SCAN TO SEE APPLICATION LIST



STEEL



DISC GUARD

•2CP140_

DISC GUARD ALUMINUM
•2CP041_

- » Replace the (****) for the code of the desired color Example: Red Color 2CP00100010007
- » Substituir os (****) pelo código de cor pretendida:Exemplo: para a cor vermelha 2CP00100010007

»0001	»0002	»0004	»0005	»0006	»0007	»0008	»0009	»0010	»0011
Ice Matte Ice Polish	Polish Polido	Black Preto	Textured Black Preto Texturado	White Branco	Red Vermelho	Yellow Amarelo	Green Verde	Orange Laranja	Blue Azul



Available in various colors
See page: 147

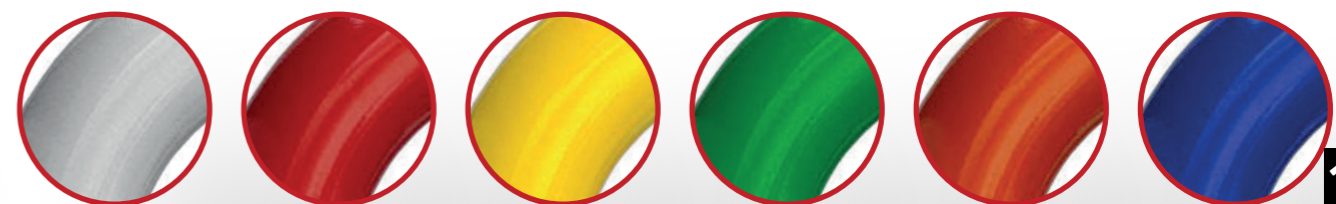
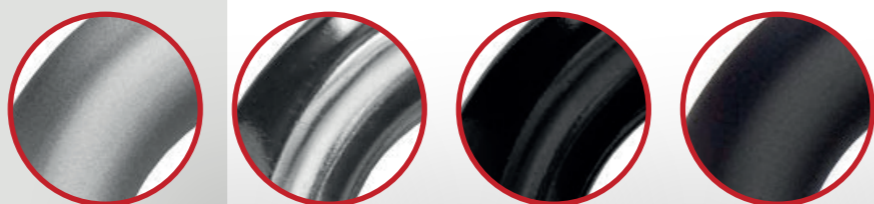

ride and ENJOY IT



CHAIN PROTECTION

• 2CP099_

QUAD ACCESSÓRIAS



CHAIN PROTECTION

• 2CP042_

Available in various colors
See page: 147

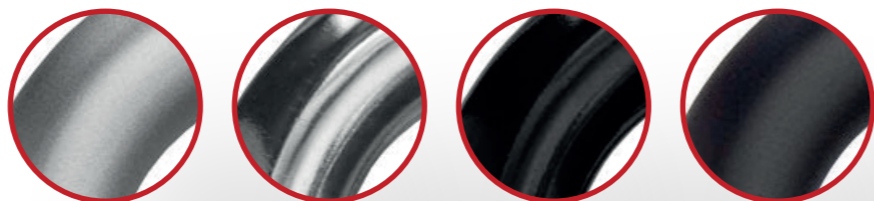











SCAN TO SEE APPLICATION LIST

FRAME GUARDS



- » Replace the (****) for the code of the desired color Example: Red Color 2CP00100010007
- » Substituir os (****) pelo código de cor pretendida: Exemplo: para a cor vermelha 2CP00100010007

 »0001	 »0002	 »0004	 »0005	 »0006	 »0007	 »0008	 »0009	 »0010	 »0011
Ice Matte Ice Polish	Polish Polido	Black Preto	Textured Black Preto Texturado	White Branco	Red Vermelho	Yellow Amarelo	Green Verde	Orange Laranja	Blue Azul

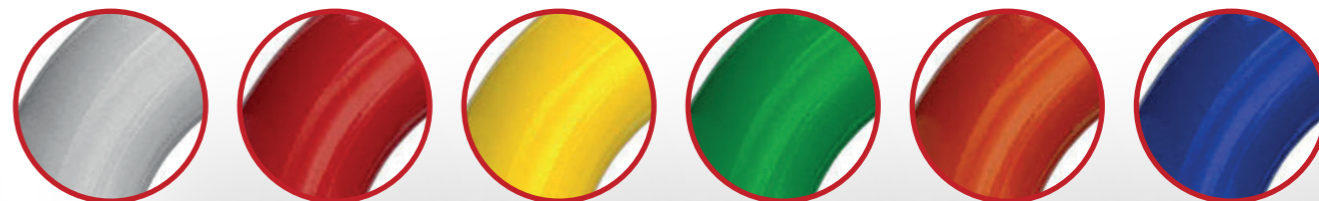

SHOCK ABSORBER PROTECTION



ENGINE CONTROL PROTECTION



Available in various colors
See page: 147



FRONT RADIATOR PROTECTION



- » Replace the (****) for the code of the desired color Example: Red Color 2CP00100010007
- » Substituir os (****) pelo código de cor pretendida: Exemplo: para a cor vermelha 2CP00100010007

»0001	»0002	»0004	»0005	»0006	»0007	»0008	»0009	»0010	»0011
Ice Matte Ice Polish	Polish Polido	Black Preto	Textured Black Preto Texturado	White Branco	Red Vermelho	Yellow Amarelo	Green Verde	Orange Laranja	Blue Azul

Available in various colors
See page: 147

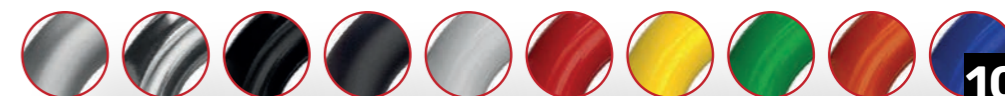

ride and **ENJOY IT**

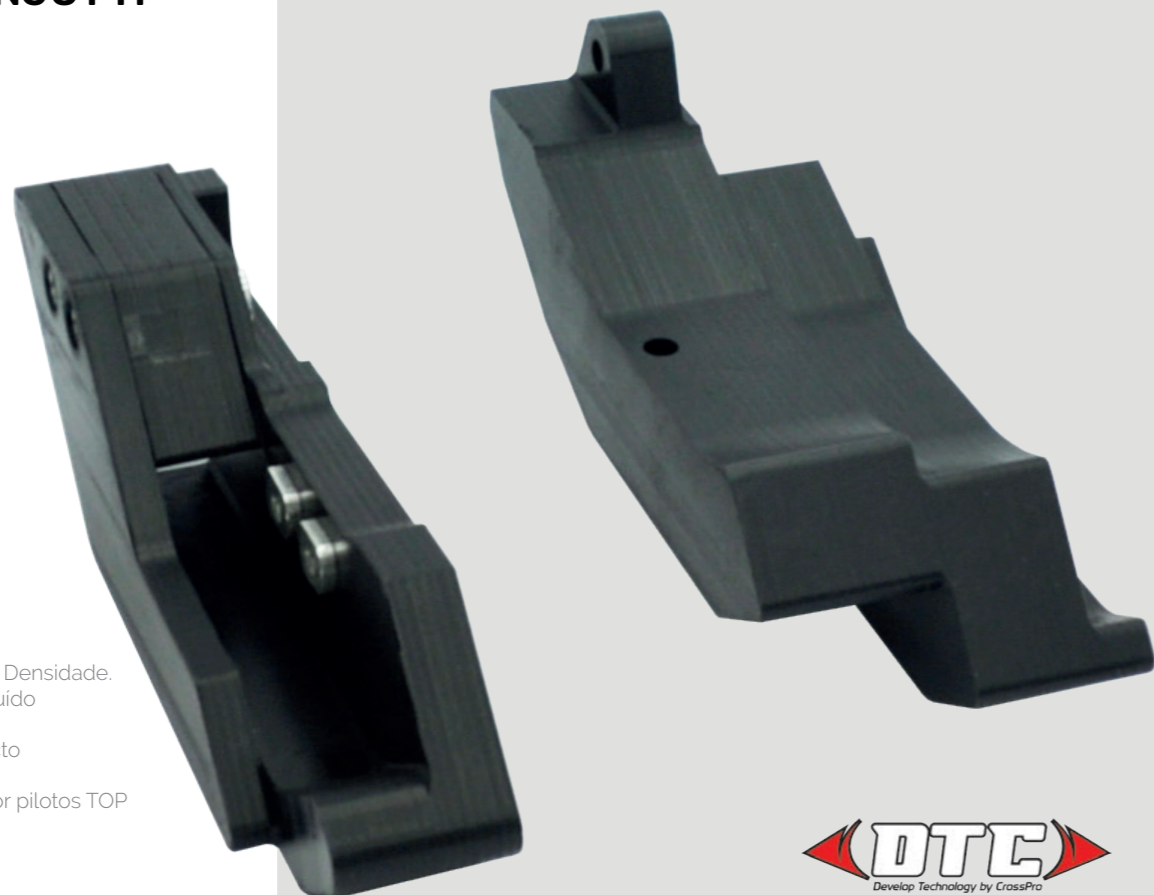

- »Conceito Inovador
- »Fabricado em DTC de Alta Densidade.
- »Não vibra e não provoca ruído
- »Sem soldas
- »Maior resistência ao impacto
- »100% maquinada
- »Testado intensivamente por pilotos TOP

- »Innovative concept
- »Manufactured of a high density DTC
- »Does not rattle or vibrate
- »No Welds
- »Impact Resistance
- »100% Machined
- »Intensely tested by top ATV pilots

DTC DISC GUARD

• 2CP120001A0300 SUZUKI LT-R 450 (all)



SCAN TO SEE APPLICATION LIST



*Pinhão não incluído
*Front sprocket not included



DTC CASE SAVER

• 2CP12800230300
YAMAHA YFZ350 Banshee



»De forma assegurar a máxima protecção da sua moto, a Crosspro oferece uma gama de capas de amortecedores.

»Estas protecções protegem não só contra o pó e lama mas também contra pedras e outros objectos.

»In order to ensure maximum protection of your motorcycle, CROSSPRO offers a range of dampers covers.

»These protections not only protect against dust and mud, but also against stones and other objects.

SHOCK COVERS

• 2CP075_



•2CP049_

»A Pega Traseira "Racing", foi desenvolvida para uma utilização em competição, o seu porta número, permite ao piloto colocar o seu número ou identificação, não interferindo com a sua condução e segurança.

»Permitindo uma completa personalização, disponível em diferentes cores e acabamentos.

»TheRearHold "Racing", was developed for a utilization in competition, the number hold allows to the pilot to put his number or identification, without it interferes on his driving or safety.

»Allows a complete personalization, available in different colors and finishing's.

REAR HOLD RACING

- complete with number plate

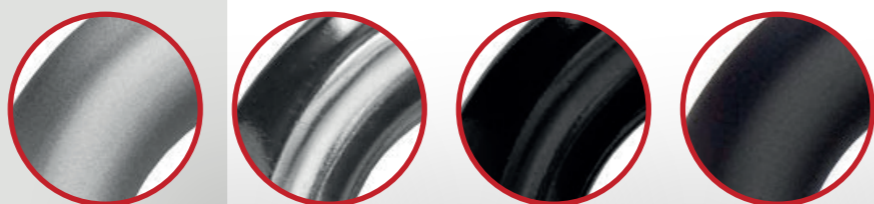

ALUMINUM REAR HOLDS



STANDARD REAR HOLD
•2CP048_

»As pegas traseiras, além da sua função habitual, pode ainda ser utilizada para suporte de luzes, porta matrículas e porta números.

»A CrossPro oferece dois modelos de pegas traseiras Tipo Origem e Racing, este último mais completo, disponíveis em vários acabamentos permite uma personalização da sua moto adequada às suas preferências.

»The rear handle bars, in addition to its usual function, can also be used to support lights, plates and numbers.
»CROSSPRO offers two models, Origin and Racing, the Racing is more complete, available in various finishing's, allows the customization of your motorcycle suited to your preferences.

» Replace the (****) for the code of the desired color Example: Red Color 2CP04800010007

» Substituir os (****) pelo código de cor pretendida:Exemplo: para a cor vermelha 2CP04800010007

● »0001	● »0002	● »0004	● »0005	● »0006	● »0007	● »0008	● »0009	● »0010	● »0011
Ice Matte Ice Polish	Polish Polido	Black Preto	Textured Black Preto Texturado	White Branco	Red Vermelho	Yellow Amarelo	Green Verde	Orange Laranja	Blue Azul

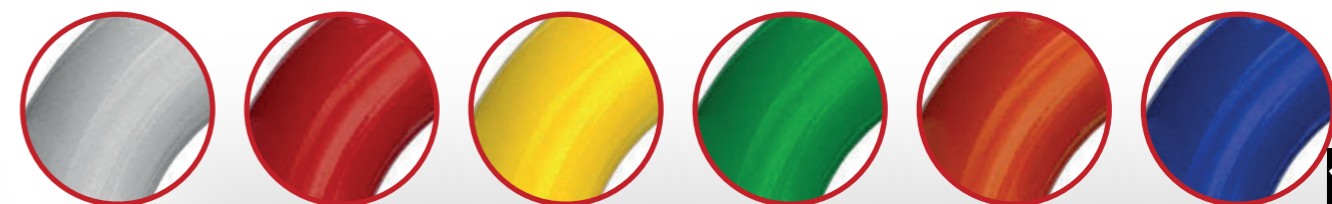



Hugo Moreira Audiovisuais

REAR HOLD STICKERS

•2CP142_



NUMBER PLATE



•2CP095000_



•2CP0950001_



•2CP0950048_



•2CP0950055_

» Replace the () for the code of the desired color Example: Red Color 2CP09500010500

» Substituir os () pelo código de cor pretendida:Exemplo: para a cor vermelha 2CP09500010500

- 0300
- 0400
- 0500
- 0600
- 0700
- 0900

Black
Preto

Blue
Azul

Red
Vermelho

White
Branco

Yellow
Amarelo

Orange
Laranja



SCAN TO SEE APPLICATION LIST

WHEEL SPACERS

•ZCP052_



SCAN TO SEE APPLICATION LIST

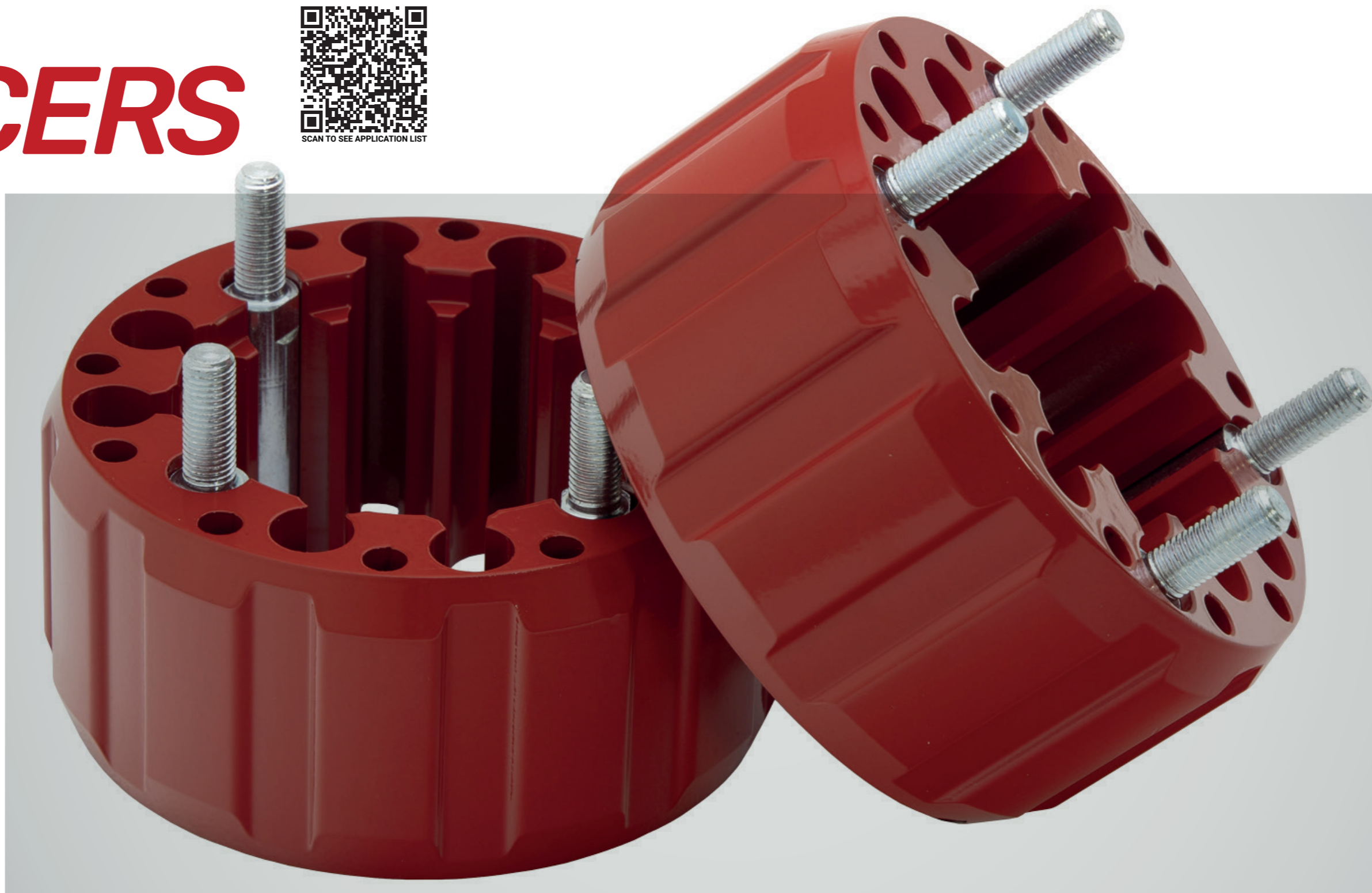

»Os Alargadores são utilizados para atribuir maior estabilidade à sua moto 4, aumentando a sua segurança, permitindo uma melhor condução e desempenho.

»Cada Kit é composto por 2 alargadores e 8 pernos

»Utilizando apenas 8 modelos de alargadores e conjugando com diferentes pernos, é possível configurar o seu alargador para todos os modelos de motos, conseguindo de forma simples ajustar e personalizar o alargador às suas necessidades.

»Esta inovação permite:

- Redução de custos e espaço de stock
- Maior comodidade para si e seus clientes

»Disponível também em vários acabamentos

»The Wheel Spacers are used to help in the stability of your moto 4, increasing your safety and allowing a better driving and performance.

»Each Kit contains 2 Wheel Spacers and 8 bolts.

»Using only 8 models of Wheel Spacers with different bolts, is possible to configure your Wheel Spacer to all moto 4 models, accomplishing in a simple way adjust and personalize the Wheel Spacer to your needs.

»This innovation allows:

- Reduce the costs and space in stock
- More convenience for you and your clients

»Available in different colors.



Available in various colors

See page: 147

Available in 45, 65 and 100mm thickness

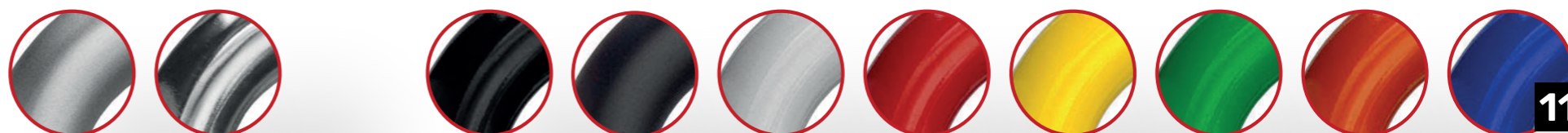

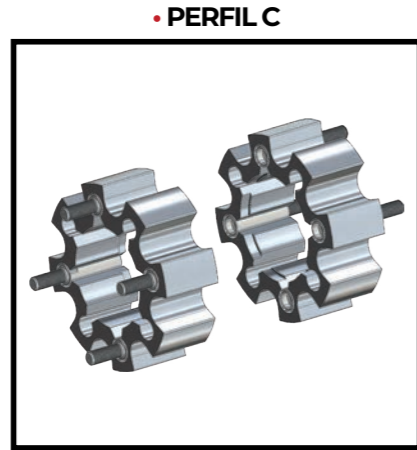

WHEEL SPACERS

• 2CP052_

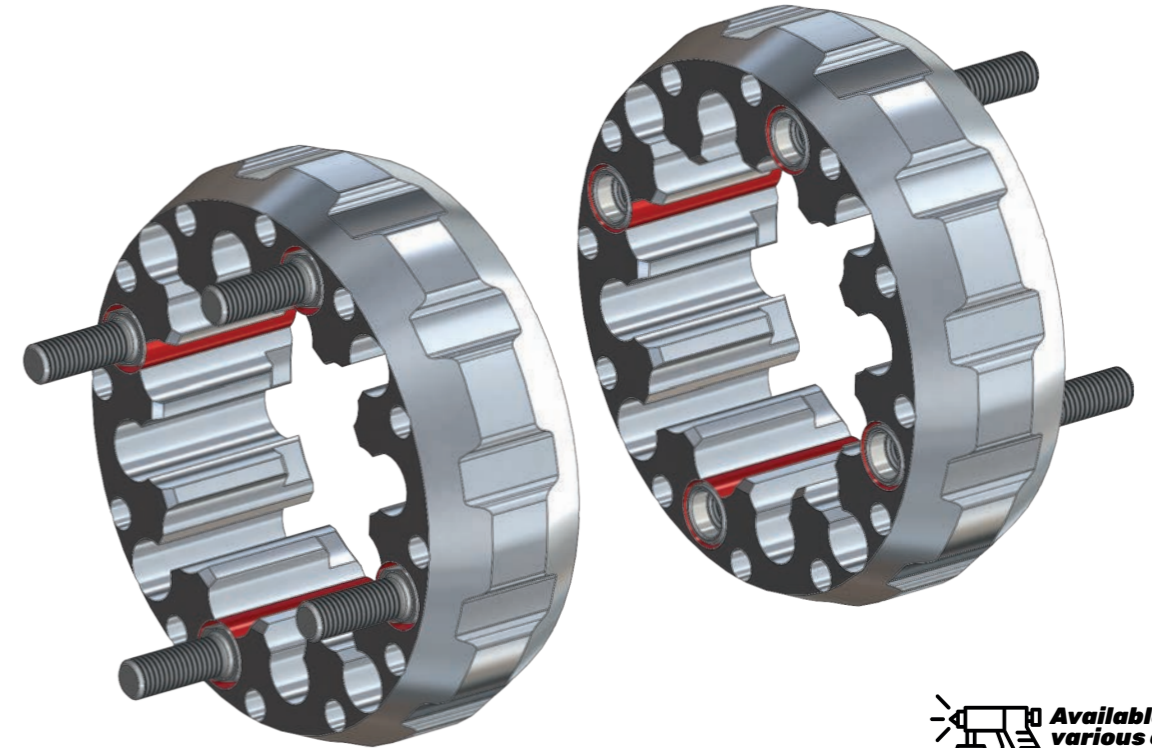

Search by size:

DISTANCE	SIZE	THREADED	NAME	45MM	65MM	100MM
100	3/8"	24	A-16	2CP0520029	2CP0520072	2CP0520098
100	3/8"	24	C-16	2CP0520056	2CP0520082	2CP0520107
100	M10	1,25	A-15	2CP0520028	2CP0520036	2CP0520037
100	M10	1,25	C-15	2CP0520043	2CP0520076	2CP0520101
100	M10	1,50	A-17	2CP0520030	2CP0520073	2CP0520099
100	M10	1,50	C-17	2CP0520057	2CP0520083	2CP0520108
101,5	1/2"	20	C-21	2CP0520034	2CP0520074	2CP0520049
101,5	M12	1,25	C-32	2CP0520059	2CP0520085	2CP0520110
101,5	M12	1,50	C-22	2CP0520058	2CP0520084	2CP0520109
110	1/2"	20	I-21	2CP0520065	2CP0520091	2CP0520116
110	3/8"	24	A-16	2CP0520029	2CP0520072	2CP0520098
110	M10	1,25	A-15	2CP0520028	2CP0520036	2CP0520037
110	M10	1,50	A-17	2CP0520030	2CP0520073	2CP0520099
110	M12	1,25	I-32	2CP0520066	2CP0520092	2CP0520117
110	M12	1,50	I-22	2CP0520051	2CP0520078	2CP0520103
115	3/8"	24	A-16	2CP0520029	2CP0520072	2CP0520098
115	M10	1,25	A-15	2CP0520028	2CP0520036	2CP0520037
115	M10	1,50	A-17	2CP0520030	2CP0520073	2CP0520099
136,5	1/2"	20	J-21	2CP0520070	2CP0520096	2CP0520121
136,5	3/8"	24	D-16	2CP0520053	2CP0520079	2CP0520104
136,5	3/8"	24	*G-16	2CP0520048	2CP0520077	2CP0520102
136,5	M10	1,25	D-15	2CP0520042	2CP0520075	2CP0520100
136,5	M10	1,25	*G-15	2CP0520060	2CP0520086	2CP0520111
136,5	M10	1,50	D-17	2CP0520054	2CP0520080	2CP0520105

DISTANCE	SIZE	THREADED	NAME	45MM	65MM	100MM
136,5	M10	1,50	*G-17	2CP0520061	2CP0520087	2CP0520112
136,5	M12	1,25	J-32	2CP0520071	2CP0520097	2CP0520122
136,5	M12	1,50	J-22	2CP0520055	2CP0520081	2CP0520106
144	3/8"	24	D-16	2CP0520053	2CP0520079	2CP0520104
144	3/8"	24	*G-16	2CP0520048	2CP0520077	2CP0520102
144	M10	1,25	D-15	2CP0520042	2CP0520075	2CP0520100
144	M10	1,25	*G-15	2CP0520060	2CP0520086	2CP0520111
144	M10	1,50	D-17	2CP0520054	2CP0520080	2CP0520105
144	M10	1,50	*G-17	2CP0520061	2CP0520087	2CP0520112
156	1/2"	20	J-21	2CP0520070	2CP0520096	2CP0520121
156	3/8"	24	D-16	2CP0520053	2CP0520079	2CP0520104
156	3/8"	24	*G-16	2CP0520048	2CP0520077	2CP0520102
156	M10	1,25	D-15	2CP0520042	2CP0520075	2CP0520100
156	M10	1,25	*G-15	2CP0520060	2CP0520086	2CP0520111
156	M10	1,50	D-17	2CP0520054	2CP0520080	2CP0520105
156	M10	1,50	*G-17	2CP0520061	2CP0520087	2CP0520112
156	M12	1,25	J-32	2CP0520071	2CP0520097	2CP0520122
156	M12	1,50	J-22	2CP0520055	2CP0520081	2CP0520106
156,4	1/2"	20	J-21	2CP0520070	2CP0520096	2CP0520121
156,4	M12	1,25	J-32	2CP0520071	2CP0520097	2CP0520122
156,4	M12	1,50	J-22	2CP0520055	2CP0520081	2CP0520106

* SPECIAL MACHINING



» Replace the ("") for the code of the desired color Example: Red Color 2CP05200010007

» Substituir os ("") pelo código de cor pretendida.Exemplo: para a cor vermelha 2CP05200010007

- »0001
Ice Matte
Ice Polish
- »0002
Polish
Polido
- »0004
Black
Preto
- »0005
Textured
Black
Preto
Texturado
- »0006
White
Branco
- »0007
Red
Vermelho
- »0008
Yellow
Amarelo
- »0009
Green
Verde
- »0010
Orange
Laranja
- »0011
Blue
Azul

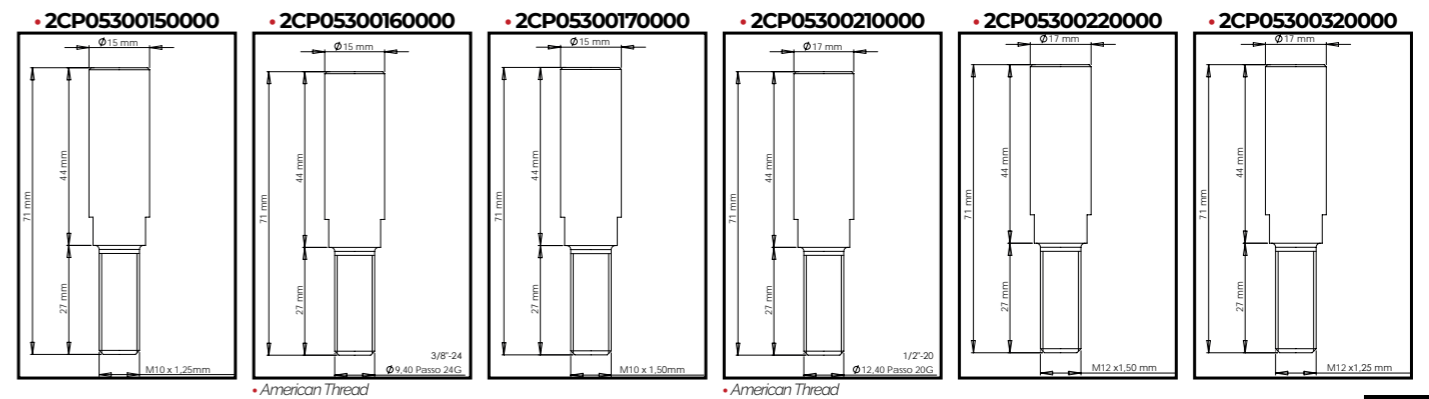

» **Protege o mais importante com Crosspro**

Além das protecções para o seu ATV e UTV, a CrossPro aposta em produtos que permitem maximizar a sua segurança.

Conjugando um vasto conhecimento sobre estes equipamentos e os melhores materiais, a CrossPro oferece uma gama completa de protecções e acessórios que lhe permitirão usufruir da melhor forma da sua moto.

Desenvolvida e construída por profissionais qualificados, esta é a protecção adequada a um cliente ciente da importância da protecção da sua moto.

» **Protect the important with CrossPro**

Besides the ATV and UTV protections, CrossPro bets on products that allow maximizing your safety.

Combining the knowledge of these equipments with the best materials, CrossPro offers a complete range of protections and accessories that will allow you to enjoy your moto.

Developed and built by skilled professionals, this is adequate protection to a customer who knows the importance of protecting his bike.



utility **ATV's**
HARD
PROTECTION

ALUMINUM PROTECTION ATV

»A Crosspro apresenta a gama mais completa do mercado de protecções para ATVs e UTVs.
 »Prozuidos com Alumínio de 5mm de espessura, as protecções Crosspro protegem cada cm do seu ATV/UTV.
 »Todas as protecções encaixam perfeitamente umas nas outras, por forma a proporcionar a maior estabilidade, protecção e resistência.

»Crosspro presents the most complete range of protections parts for your ATVs and UTVs.
 »Produced with 5mm thickness, Crosspro Protection parts protect every cm of your ATV/UTV.
 »All ATV parts interlocks with each other in order to give maximum stability, strength and protection

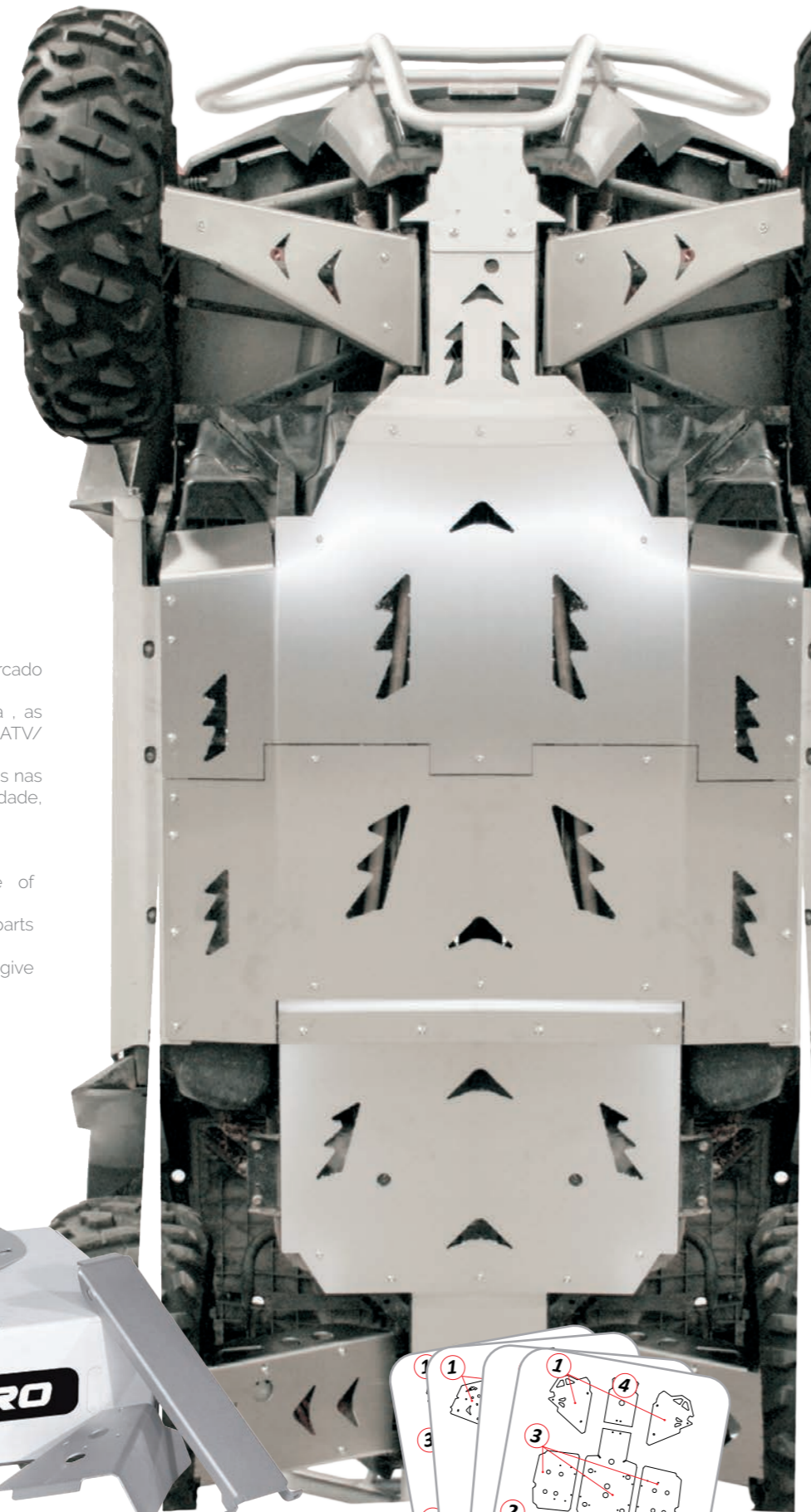

CAN-AM	COLOR	COMPLET KIT	(1)FRONT A-ARMS	(2)REAR A-ARMS	(3)CENTRAL CARTER	(4)FRONT CARTER	(5)REAR CARTER	(6)CARDAN
500/650/800 Outlander (2006-2012)	● Ice Matte	2CP055035A0001	2CP03800350001	2CP03900430001	2CP06600350001	2CP06400350001	2CP06500350001	2CP10500430001
	● Black	2CP055035A0004	2CP03800350004	2CP03900430004	2CP06600350004	2CP06400350004	2CP06500350004	2CP10500430004
	● Textured Black	2CP055035A0005	2CP03800350005	2CP03900430005	2CP06600350005	2CP06400350005	2CP06500350005	2CP10500430005
500/650/800 Outlander MAX (2006-2012)	● Ice Matte	2CP055043A0001	2CP03800430001	2CP03900430001	2CP06600430001	2CP06400430001	2CP06500430001	2CP10500430001
	● Black	2CP055043A0004	2CP03800430004	2CP03900430004	2CP06600430004	2CP06400430004	2CP06500430004	2CP10500430004
	● Textured Black	2CP055043A0005	2CP03800430005	2CP03900430005	2CP06600430005	2CP06400430005	2CP06500430005	2CP10500430005
500/800 Renegade (2008-2012)	● Ice Matte	2CP055042A0001	2CP03800420001	2CP03900430001	2CP06600420001	2CP06400420001	2CP06500420001	2CP10500430001
	● Black	2CP055042A0004	2CP03800420004	2CP03900430004	2CP06600420004	2CP06400420004	2CP06500420004	2CP10500430004
	● Textured Black	2CP055042A0005	2CP03800420005	2CP03900430005	2CP06600420005	2CP06400420005	2CP06500420005	2CP10500430005
1000 Outlander X MR (2013-2015)	● Ice Matte	2CP05500850001	2CP03800860001	2CP03900860001	2CP06600860001	2CP06400860001	2CP06500850001	-
	● Black	2CP05500850004	2CP03800860004	2CP03900860004	2CP06600860004	2CP06400860004	2CP06500850004	-
	● Textured Black	2CP05500850005	2CP03800860005	2CP03900860005	2CP06600860005	2CP06400860005	2CP06500850005	-
1000 Outlander Maxx (2013-2016)	● Ice Matte	2CP05500860001	2CP03800860001	2CP03900860001	2CP06600860001	2CP06400860001	2CP06500860001	-
	● Black	2CP05500860004	2CP03800860004	2CP03900860004	2CP06600860004	2CP06400860004	2CP06500860004	-
	● Textured Black	2CP05500860005	2CP03800860005	2CP03900860005	2CP06600860005	2CP06400860005	2CP06500860005	-
1000 Outlander Maxx (2017-2018)	● Ice Matte	2CP05500930001	2CP03800930001	2CP03900930001	2CP06600930001	2CP06400930001	2CP06500930001	-
	● Black	2CP05500930004	2CP03800930004	2CP03900930004	2CP06600930004	2CP06400930004	2CP06500930004	-
	● Textured Black	2CP05500930005	2CP03800930005	2CP03900930005	2CP06600930005	2CP06400930005	2CP06500930005	-
1000 Renegade (2012-2015)	● Ice Matte	2CP05500790001	2CP03800790001	2CP03900790001	2CP06600790001	2CP06400790001	2CP06500790001	2CP10500790001
	● Black	2CP05500790004	2CP03800790004	2CP03900790004	2CP06600790004	2CP06400790004	2CP06500790004	2CP10500790004
	● Textured Black	2CP05500790005	2CP03800790005	2CP03900790005	2CP06600790005	2CP06400790005	2CP06500790005	2CP10500790005
GOES	COLOR	COMPLET KIT	(1)FRONT A-ARMS	(2)REAR A-ARMS	(3)CENTRAL CARTER	(4)FRONT CARTER	(5)REAR CARTER	(6)CARDAN
520 Max (all years)	● Ice Matte	2CP05500530001	2CP03800530001	2CP03900530001	2CP06600530001	2CP06400530001	2CP06500530001	-
	● Black	2CP05500530004	2CP03800530004	2CP03900530004	2CP06600530004	2CP06400530004	2CP06500530004	-
	● Textured Black	2CP05500530005	2CP03800530005	2CP03900530005	2CP06600530005	2CP06400530005	2CP06500530005	-
HONDA	COLOR	COMPLET KIT	(1)FRONT A-ARMS	(2)REAR A-ARMS	(3)CENTRAL CARTER	(4)FRONT CARTER	(5)REAR CARTER	(6)CARDAN
680 Rincon (2008-2014)	● Ice Matte	2CP05500500001	2CP03800500001	2CP03900500001	2CP06600500001	2CP06400500001	2CP06500500001	-
	● Black	2CP05500500004	2CP03800500004	2CP03900500004	2CP06600500004	2CP06400500004	2CP06500500004	-
	● Textured Black	2CP05500500005	2CP03800500005	2CP03900500005	2CP06600500005	2CP06400500005	2CP06500500005	-
KAWASAKI	COLOR	COMPLET KIT	(1)FRONT A-ARMS	(2)REAR A-ARMS	(3)CENTRAL CARTER	(4)FRONT CARTER	(5)REAR CARTER	(6)CARDAN
650 Brute Force (2005-2013)	● Ice Matte	2CP05500400001	2CP03800400001	-	2CP06600400001	-	2CP06500400001	-
	● Black	2CP05500400004	2CP03800400004	-	2CP06600400004	-	2CP06500400004	-
	● Textured Black	2CP05500400005	2CP03800400005	-	2CP06600400005	-	2CP06500400005	-
750 Brute Force (2008-2011)	● Ice Matte	2CP05500370001	2CP03800370001	2CP03900370001	2CP06600370001	2CP06400370001	2CP06500370001	-
	● Black	2CP05500370004	2CP03800370004	2CP03900370004	2CP06600370004	2CP06400370004	2CP06500370004	-
	● Textured Black	2CP05500370005	2CP03800370005	2CP03900370005	2CP06600370005	2CP06400370005	2CP06500370005	-
750 KVF 4x4 (2008-2011)	● Ice Matte	2CP05500520001	2CP03800520001	2CP03900520001	2CP06600520001	2CP06400520001	2CP06500520001	-
	● Black	2CP05500520004	2CP03800520004	2CP03900520004	2CP06600520004	2CP06400520004	2CP06500520004	-
	● Textured Black	2CP05500520005	2CP03800520005	2CP03900520005	2CP06600520005	2CP06400520005	2CP06500520005	-
KYMC0	COLOR	COMPLET KIT	(1)FRONT A-ARMS	(2)REAR A-ARMS	(3)CENTRAL CARTER	(4)FRONT CARTER	(5)REAR CARTER	(6)CARDAN
500 MXU (2009-2010)	● Ice Matte	2CP05500390001	2CP03800390001	-	2CP06600390001	-	2CP06500390001	-
	● Black	2CP05500390004	2CP03800390004	-	2CP06600390004	-	2CP06500390004	-
	● Textured Black	2CP05500390005	2CP03800390005	-	2CP06600390005	-	2CP06500390005	-
POLARIS	COLOR	COMPLET KIT	(1)FRONT A-ARMS	(2)REAR A-ARMS	(3)CENTRAL CARTER	(4)FRONT CARTER	(5)REAR CARTER	(6)CARDAN
500 Scrambler HO (2005-2007)	● Ice Matte	2CP05500410001	2CP03800410001	-	2CP06600410001	2CP06400410001	2CP06500410001	-
	● Black	2CP05500410004	2CP03800410004	-	2CP06600410004	2CP06400410004	2CP06500410004	-
	● Textured Black	2CP05500410005	2CP03800410005	-	2CP06600410005	2CP06400410005	2CP06500410005	-
500/800 Sportsman EFI X2 (2008-2009)	● Ice Matte	2CP05500460001	2CP03800460001	2CP03900460001	2CP06600460001	2CP06400460001	2CP06500460001	-
	● Black	2CP05500460004	2CP03800460004	2CP03900460004	2CP06600460004	2CP06400460004	2CP06500460004	-
	● Textured Black	2CP05500460005	2CP03800460005	2CP03900460005	2CP06600460005	2CP06400460005	2CP06500460005	-
700/800 Sportsman TWIN	● Ice Matte	2CP05500380001	2CP03800380001	2CP03900380001	2CP06600380001	2CP06400380001	-	-
	● Black	2CP05500380004	2CP03800380004	2CP03900380004	2CP06600380004	2CP06400380004	-	-
	● Textured Black	2CP05500380005	2CP03800380005	2CP03900380005	2CP06600380005	2CP06400380005	-	-
850 Sportsman XP (2009)	● Ice Matte	2CP05500600001	2CP03800600001	2CP03900600001	2CP06600600001	2CP06400600001	2CP06500600001	-
	● Black	2CP05500600004	2CP03800600004	2CP03900600004	2CP06600600004	2CP06400600004	2CP06500600004	-
	● Textured Black	2CP05500600005	2CP03800600005	2CP03900600005	2CP06600600005	2CP06400600005	2CP06500600005	-
TGB	COLOR	COMPLET KIT	(1)FRONT A-ARMS	(2)REAR A-ARMS	(3)CENTRAL CARTER	(4)FRONT CARTER	(5)REAR CARTER	(6)CARDAN
250 Blade (2008)	● Ice Matte	2CP05500560001	2CP03800560001	-	2CP06600560001	2CP06400560001	2CP06500560001	-
	● Black	2CP05500560004	2CP03800560004	-	2CP06600560004	2CP06400560004	2CP06500560004	-
	● Textured Black	2CP05500560005	2CP03800560005	-	2CP06600560005	2CP06400560005	2CP06500560005	-
425 Blade (2008)	● Ice Matte	2CP05500570001	2CP03800570001	-	2CP06600570001	2CP06400570001	2CP06500570001	-
	● Black	2CP05500570004	2CP03800570004	-	2CP06600570004	2CP06400570004	2CP06500570004	-
	● Textured Black	2CP05500570005	2CP03800570005	-	2CP06600570005	2CP06400570005	2CP06500570005	-
SUZUKI	COLOR	COMPLET KIT	(1)FRONT A-ARMS	(2)REAR A-ARMS	(3)CENTRAL CARTER	(4)FRONT CARTER	(5)REAR CARTER	(6)CARDAN
450 King Quad (2007-2010)	● Ice Matte	2CP05500620001	2CP03800620001	2CP03900620001	2CP06600620001	2CP06400620001	2CP06500620001	-
	● Black	2CP05500620004	2CP03800620004	2CP03900620004	2CP06600620004	2CP06400620004	2CP06500620004	-
	● Textured Black	2CP05500620005	2CP03800620005	2CP03900620005	2CP06600620005	2CP06400620005	2CP06500620005	-
750 King Quad	● Ice Matte	2CP05500620001	2CP03800620001	2CP03900620001	2CP06600620001	2CP06400620001	2CP06500620001	-
	● Black	2CP05500620004	2CP03800620004	2CP03900620004	2CP06600620004	2CP06400620004	2CP06500620004	-
	● Textured Black	2CP05500620005	2CP03800620005	2CP03900620005	2CP06600620005	2CP06400620005	2CP06500620005	-
750 King Quad AXI 4X4 (2008-2009)	● Ice Matte	2CP05500620001	2CP03800620001	2CP03900620001	2CP06600620001	2CP06400620001	2CP06500620001	-
	● Black	2CP05500620004	2CP03800620004	2CP03900620004	2CP06600620004	2CP06400620004	2CP06500620004	-
	● Textured Black	2CP05500620005	2CP03800620005	2CP03900620005	2CP06600620005	2CP06400620005	2CP06500620005	-
YAMAHA	COLOR	COMPLET KIT	(1)FRONT A-ARMS	(2)REAR A-ARMS	(3)CENTRAL CARTER	(4)FRONT CARTER	(5)REAR CARTER	(6)CARDAN
450 Kodiak (2008-2010)	● Ice Matte	2CP05500720001	2CP03800720001	2CP03900720001	2CP06600720001	2CP06400720001	2CP06500720001	-
	● Black	2CP05500720004	2CP03800720004	2CP03900720004	2CP06600720004	2CP06400720004	2CP06500720004	-
	● Textured Black	2CP05500720005	2CP03800720005	2CP03900720005	2CP06600720005	2CP06400720005	2CP06500720005	-
450 Grizzly (2008-2010)	● Ice Matte	2CP05500720001	2CP03800720001	2CP03900720001	2CP06600720001	2CP06400720001	2CP06500720001	-
	● Black	2CP05500720004	2CP03800720004	2CP03900720004	2CP06600720004	2CP06400720004	2CP06500720004	-
	● Textured Black	2CP05500720005	2CP03800720005	2CP03900720005	2CP06600720005	2CP06400720005	2CP06500720005	-
660 Grizzly (2002-2008)	● Ice Matte	2CP05500360001	2CP03800360001	2CP03900360001	2CP06600360001	2CP06400360001	2CP06500360001	-
	● Black	2CP05500360004	2CP03800360004	2CP03900360004	2CP06600360004	2CP06400360004	2CP06500360004	-
	● Textured Black	2CP05500360005	2CP03800360005	2CP03900360005	2CP06600360005	2CP06400360005	2CP06500360005	-
700 Grizzly (2007-2013)	● Ice Matte	2CP05500470001	2CP03800470001	2CP03900470001	2CP06600470001	2CP06400470001	2CP06500470001	-
	● Black	2CP05500470004	2CP03800470004	2CP03900470004	2CP06600470004	2CP06		



DTC PROTECTION ATV

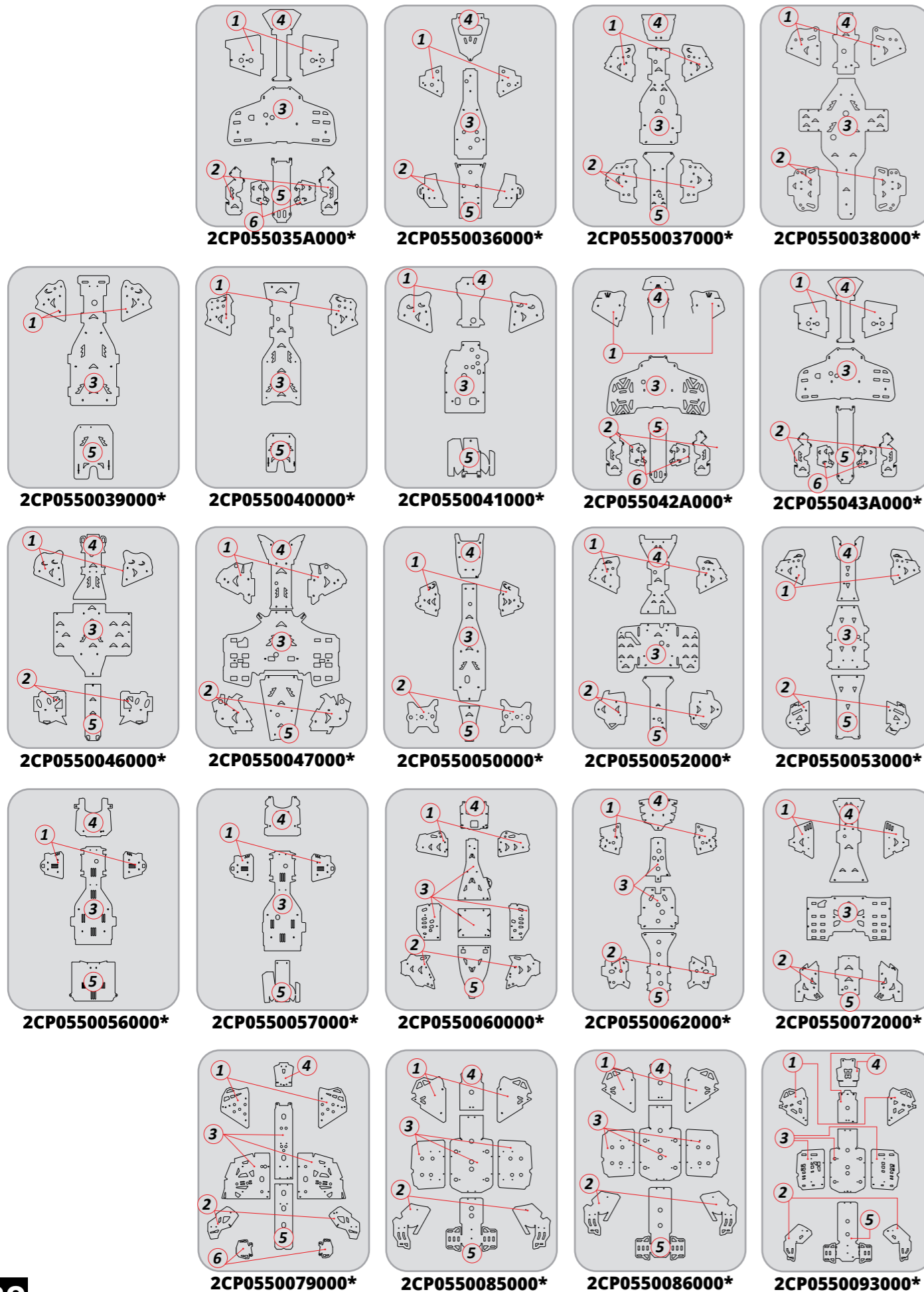

CAN-AM	COLOR	COMPLET KIT	(1)FRONT A-ARMS	(2)REAR A-ARMS	(3)CENTRAL CARTER	(4)FRONT CARTER	(5)REAR CARTER	(6)CARDAN
500/650/800 Outlander (2006-2012)	● Black	2CP13900350300	2CP04500350300	-	2CP14300350300	2CP14400350300	2CP14500350300	-
	● Blue	-	2CP04500350400	-	-	-	-	-
	● Red	-	2CP04500350500	-	-	-	-	-
	○ White	-	2CP04500350600	-	-	-	-	-
	● Yellow	-	2CP04500350700	-	-	-	-	-
500/650/800 Outlander MAX (2006-2012)	● Orange	2CP04500350900	-	-	-	-	-	-
	● Black	2CP13900430300	2CP04500430300	-	2CP14300430300	2CP14400430300	2CP14500430300	-
	● Blue	-	2CP04500430400	-	-	-	-	-
	● Red	-	2CP04500430500	-	-	-	-	-
	○ White	-	2CP04500430600	-	-	-	-	-
1000 Outlander Maxx (2013-2015)	● Yellow	-	2CP04500430700	-	-	-	-	-
	● Orange	-	2CP04500430900	-	-	-	-	-
	● Black	2CP13900860300	2CP04500860300	2CP11600860300	2CP14300860300	2CP14400420300	2CP14500420300	-
	● Blue	-	2CP04500860400	2CP11600860400	-	-	-	-
	● Red	-	2CP04500860500	2CP11600860500	-	-	-	-
1000 Outlander X MR (2013-2015)	○ White	-	2CP04500860600	2CP11600860600	-	-	-	-
	● Yellow	-	2CP04500860700	2CP11600860700	-	-	-	-
	● Orange	-	2CP04500860900	2CP11600860900	-	-	-	-
	● Black	2CP13900850300	2CP04500850300	2CP11600850300	2CP14300850300	2CP14400850300	2CP14500850300	-
	● Blue	-	2CP04500850400	2CP11600850400	-	-	-	-
1000 Renegade (2012-2015)	● Red	-	2CP04500850500	2CP11600850500	-	-	-	-
	○ White	-	2CP04500850600	2CP11600850600	-	-	-	-
	● Yellow	-	2CP04500850700	2CP11600850700	-	-	-	-
	● Orange	2CP13900790300	2CP04500790300	2CP11600790300	2CP14300790300	2CP14400790300	2CP14500790300	2CP14600790300
	● Black	-	2CP04500790400	2CP11600790400	-	-	-	2CP14600790400
	● Blue	-	2CP04500790500	2CP11600790500	-	-	-	2CP14600790500
	● Red	-	2CP04500790600	2CP11600790600	-	-	-	2CP14600790600
	○ White	-	2CP04500790700	2CP11600790700	-	-	-	2CP14600790700
	● Yellow	-	2CP04500790800	2CP11600790800	-	-	-	2CP14600790800
	● Orange	-	2CP04500790900	2CP11600790900	-	-	-	2CP14600790900

»A Crosspro apresenta a gama mais completa do mercado de protecções para ATVs e UTVs.
 »Produzidos em DTC de 8mm de espessura, as protecções Crosspro protegem cada cm do seu ATV/UTV.
 »Todas as protecções encaixam perfeitamente umas nas outras, por forma a proporcionar a maior estabilidade, protecção e resistência.

»Crosspro presents the most complete range of protection parts for your ATVs and UTVs.
 »Produced with DTC 8mm thickness, Crosspro Protection parts protect every cm of your ATV/UTV.
 »All ATV parts interlocks with each other in order to give maximum stability, strength and protection

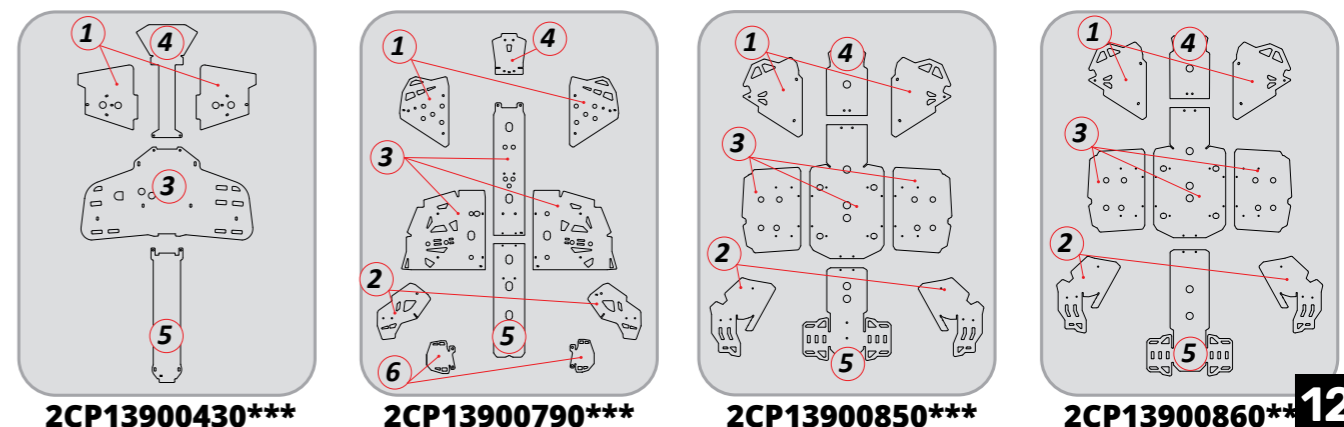
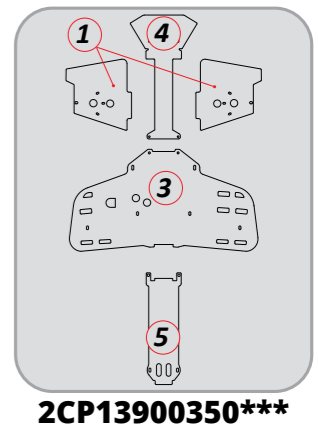



»Os Pára-choques da CrossPro para ATV's / UTV's combinam resistência com design
 »Produzidos em alumínio T6061, com tubo de 35mm
 »A melhor escolha

»The Bumper of CrossPro ATV's / UTV's strength combined with design
 »Produced in T6061 aluminum with 35mm tubing
 »The best choice

ATV BUMPERS



GOES		● ICE MATTE	● BLACK	● TEXTURED BLACK
520 Max (all years)	FRONT	2CP06200530001	2CP06200530004	2CP06200530005
	REAR	2CP06300530001	2CP06300530004	2CP06300530005
HONDA		● ICE MATTE	● BLACK	● TEXTURED BLACK
680 Rincon (2008-2014)	FRONT	2CP06200500001	2CP06200500004	2CP06200500005
	REAR	2CP06300500001	2CP06300500004	2CP06300500005
KAWASAKI		● ICE MATTE	● BLACK	● TEXTURED BLACK
750 KVF 4x4 (2008-2011)	FRONT	2CP06200520001	2CP06200520004	2CP06200520005
	REAR	2CP06300520001	2CP06300520004	2CP06300520005
KYMCO		● ICE MATTE	● BLACK	● TEXTURED BLACK
500 MXU (2009-2010)	FRONT	2CP06200390001	2CP06200390004	2CP06200390005
	REAR	2CP06300390001	2CP06300390004	2CP06300390005
POLARIS		● ICE MATTE	● BLACK	● TEXTURED BLACK
700/800 Sportsman TWIN	FRONT	2CP06200380001	2CP06200380004	2CP06200380005
	REAR	2CP06300380001	2CP06300380004	2CP06300380005
TGB		● ICE MATTE	● BLACK	● TEXTURED BLACK
425 Blade (2008)	FRONT	2CP06200570001	2CP06200570004	2CP06200570005
	REAR	2CP06300570001	2CP06300570004	2CP06300570005
SUZUKI		● ICE MATTE	● BLACK	● TEXTURED BLACK
450 King Quad (2007-2010)	FRONT	2CP06200490001	2CP06200490004	2CP06200490005
	REAR	2CP06300490001	2CP06300490004	2CP06300490005
700 King Quad (2006-2007)	FRONT	2CP06200490001	2CP06200490004	2CP06200490005
	REAR	2CP06300490001	2CP06300490004	2CP06300490005
750 King Quad	FRONT	2CP06200490001	2CP06200490004	2CP06200490005
	REAR	2CP06300490001	2CP06300490004	2CP06300490005
YAMAHA		● ICE MATTE	● BLACK	● TEXTURED BLACK
700 Grizzly (2007-2013)	FRONT	2CP06200470001	2CP06200470004	2CP06200470005
	REAR	2CP06300470001	2CP06300470004	2CP06300470005





» **Protege o mais importante com CrossPro**

Além das protecções para o seu ATV e UTV, a CrossPro aposta em produtos que permitem maximizar a sua segurança.

Conjugando num vasto conhecimento sobre estes equipamentos e os melhores materiais, a CrossPro oferece uma gama completa de protecções e acessórios que lhe permitirão usufruir da melhor forma da sua moto.

Desenvolvida e construída por profissionais qualificados, esta é a protecção adequada a um cliente ciente da importância da protecção da sua moto.

» **Protect the important with CrossPro**

Besides the ATV and UTV protections, CrossPro bets on products that allow maximizing your safety.

Combining the knowledge of these equipments with the best materials, CrossPro offers a complete range of protections and accessories that will allow you to enjoy your moto.

Developed and built by skilled professionals, this is adequate protection to a customer who knows the importance of protecting his bike.

SIDE
BY SIDE

YAMAHA

YXZ 1000R/SE

2016

Available in various colors
See page: 147

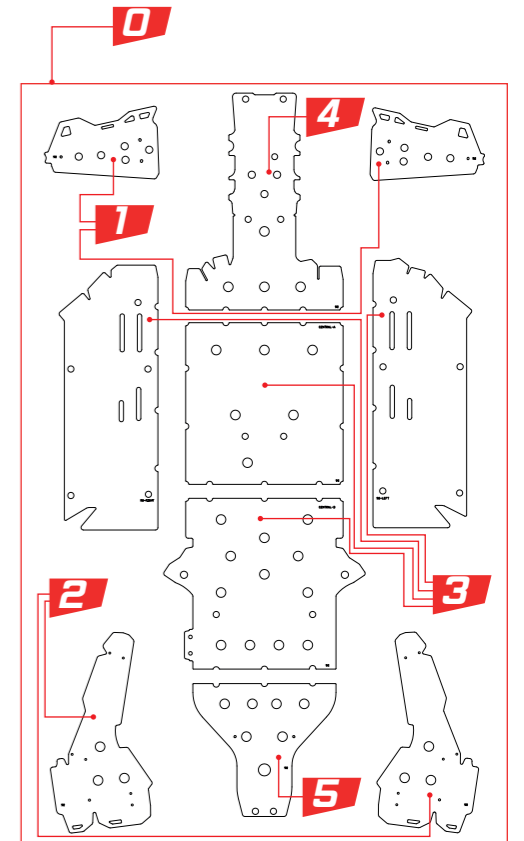

DTC 8mm ● BLACK

YXZ 1000 R 2016

0 Complet Kit Kit Completo	2CP18700920300
1 Front A-arms Triângulos da frente	2CP18800920300
2 Rear A-arms Triângulos de trás	2CP18900920300
3 Central Carter Carter Central	2CP19000920300
4 Front Carter Carter Frente	2CP19100920300
5 Rear Carter Carter trás	2CP19200920300

POLYCARBONATE ● TRANSP.

YXZ 1000 R/RSS

12 Air deflector Defletor de ar 2016-2018	2CP18500920100
12 Air deflector Defletor de ar 2019-2020	2CP1850A920100

ALUMINUM ● ICE MATTE ● NEUTRAL ● BLACK ● TEXT. BLACK ● WHITE

YXZ 1000 R 2016

0 Complet Kit Kit Completo	2CP05600920001	2CP05600920003	2CP05600920004	2CP05600920005	2CP05600920006
1 Front A-arms Triângulos da frente	2CP03800920001	2CP03800920003	2CP03800920004	2CP03800920005	2CP03800920006
2 Rear A-arms Triângulos de trás	2CP03900920001	2CP03900920003	2CP03900920004	2CP03900920005	2CP03900920006
3 Central Carter Carter Central	2CP06600920001	2CP06600920003	2CP06600920004	2CP06600920005	2CP06600920006
4 Front Carter Carter Frente	2CP06400920001	2CP06400920003	2CP06400920004	2CP06400920005	2CP06400920006
5 Rear Carter Carter Traseiro	2CP06500920001	2CP06500920003	2CP06500920004	2CP06500920005	2CP06500920006
6 Front Bumper Pára-choques Frontal	2CP06200920001	-	2CP06200920004	2CP06200920005	2CP06200920006
7 Front Bumper Pára-choques Frontal	2CP0620A920001	-	2CP0620A920004	2CP0620A920005	2CP0620A920006
8 Rear Bumper Pára-choques trás	2CP06300920001	-	2CP06300920004	2CP06300920005	2CP06300920006
9 Bottom side bar Embaladeiras	2CP05700920001	-	2CP05700920004	2CP05700920005	2CP05700920006



ARCTIC CAT

WILDCAT 1000

2012-2015

Available in various colors
See page: 147

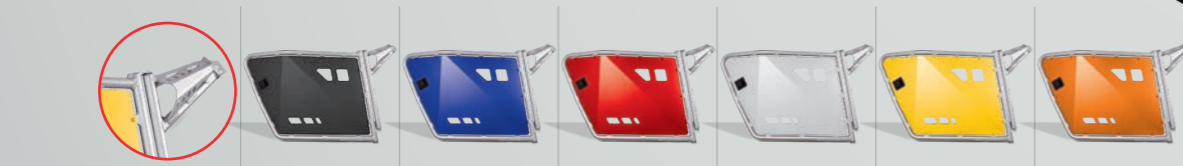
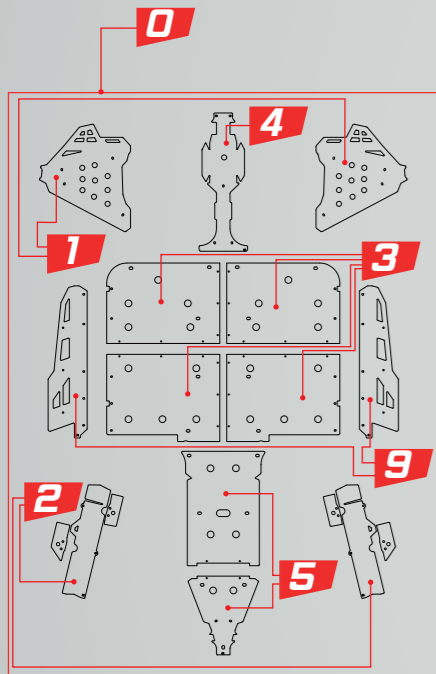

DORS WILDCAT 1000
6 FRAME ICE MATTE ● BLACK ● BLUE ● RED ○ WHITE ● YELLOW ● ORANGE
 2CP14800810301 2CP14800810401 2CP14800810501 2CP14800810601 2CP14800810701 2CP14800810801



DORS WILDCAT 1000
6 FRAME BLACK ● BLACK ● BLUE ● RED ○ WHITE ● YELLOW ● ORANGE
 2CP14800810305 2CP14800810405 2CP14800810505 2CP14800810605 2CP14800810705 2CP14800810805



ALUMINUM WILDCAT 1000	● ICE MATTE	● NEUTRAL	● BLACK	● TEXT. BLACK	○ WHITE
0 Complet Kit Kit Completo	2CP05600810001	2CP05600810003	2CP05600810004	2CP05600810005	2CP05600810006
1 Front A-arms Triângulos da frente	2CP03800810001	2CP03800810003	2CP03800810004	2CP03800810005	2CP03800810006
2 Rear A-arms Triângulos de trás	2CP03900810001	2CP03900810003	2CP03900810004	2CP03900810005	2CP03900810006
3 Central Carter Carter Central	2CP06600810001	2CP06600810003	2CP06600810004	2CP06600810005	2CP06600810006
4 Front Carter Carter Frente	2CP06400810001	2CP06400810003	2CP06400810004	2CP06400810005	2CP06400810006
5 Rear Carter Carter Traseiro	2CP06500810001	2CP06500810003	2CP06500810004	2CP06500810005	2CP06500810006
6 Side Doors Portas Laterais	2CP05000810001	-	2CP05000810004	2CP05000810005	2CP05000810006
7 Front Bumper Pára-choques Frontal	2CP06200810001	-	2CP06200810004	2CP06200810005	2CP06200810006
8 Rear Bumper Pára-choques trás	2CP06300810001	-	2CP06300810004	2CP06300810005	2CP06300810006
9 Bottom side bar Embaladeiras	2CP05700810001	-	2CP05700810004	2CP05700810005	2CP05700810006
10 Rear extenders Alargadores de trás	2CP052008280001	-	2CP052008280004	2CP052008280005	2CP052008280006
11 Front extenders Alargadores da frente	2CP052008280001	-	2CP052008280004	2CP052008280005	2CP052008280006

DTC WILDCAT 1000	● BLACK	● BLUE	● RED	○ WHITE	● YELLOW	● ORANGE
7 Front A-arms Triângulos da frente	2CP04500810300	2CP04500810400	2CP04500810500	2CP04500810600	2CP04500810700	2CP04500810900
3 Central Carter Carter Central	2CP14300810300	2CP14300810400	2CP14300810500	2CP14300810600	2CP14300810700	2CP14300810900
4 Front Carter Carter Frente	2CP14400810300	2CP14400810400	2CP14400810500	2CP14400810600	2CP14400810700	2CP14400810900
5 Rear Carter Carter Traseiro	2CP14500810300	2CP14500810400	2CP14500810500	2CP14500810600	2CP14500810700	2CP14500810900

ride and ENJOY IT

CAN-AM COMMANDER XT 800/1000 2012-2015



Available in various colors
See page: 147

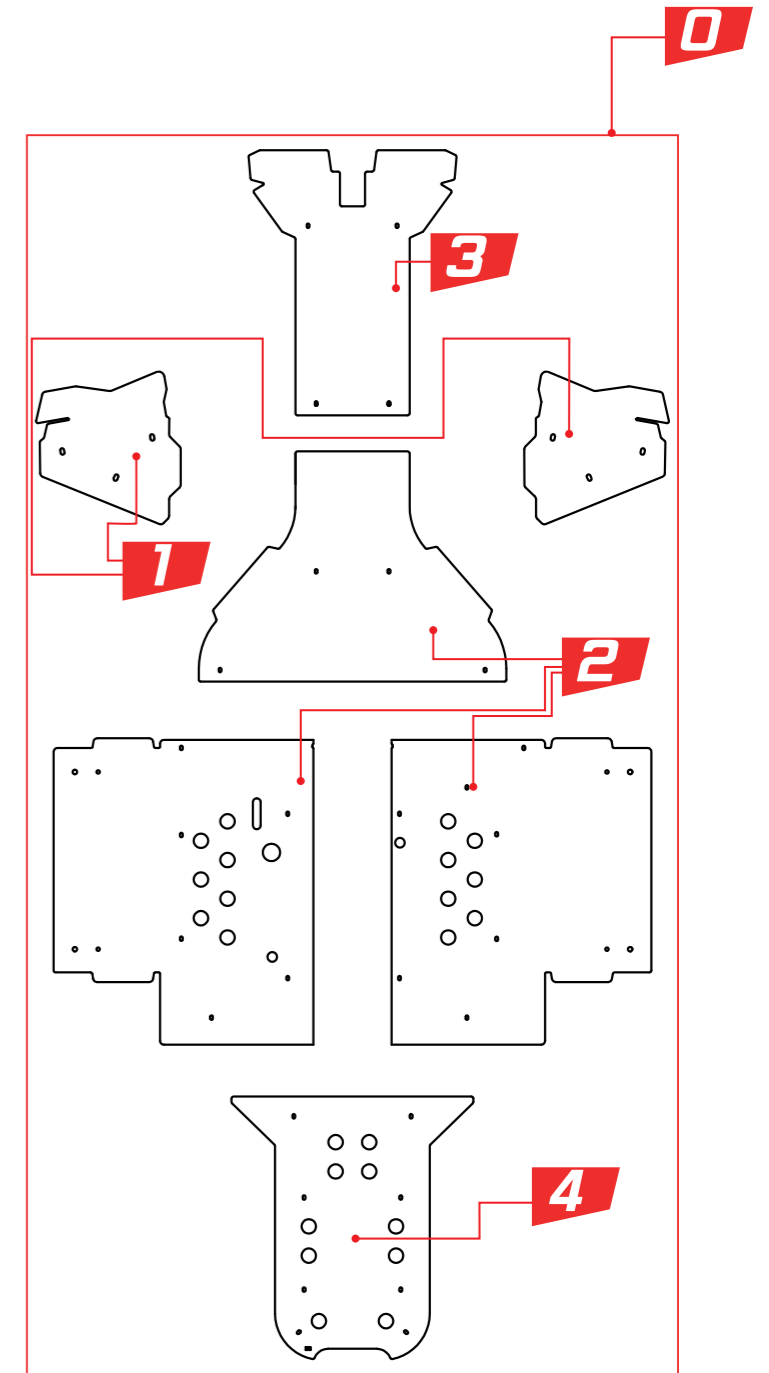

ALUMINUM XT 800/1000 12-15	● ICE MATTE	● NEUTRAL	● BLACK	● TEXT. BLACK	○ WHITE
0 Complet Kit Kit Completo	2CP05600630001	2CP05600630003	2CP05600630004	2CP05600630005	2CP05600630006
1 Front A-arms Triângulos da frente	2CP03800630001	2CP03800630003	2CP03800630004	2CP03800630005	2CP03800630006
2 Central Carter Carter Central	2CP06600630001	2CP06600630003	2CP06600630004	2CP06600630005	2CP06600630006
3 Front Carter Carter Frente	2CP06400630001	2CP06400630003	2CP06400630004	2CP06400630005	2CP06400630006
4 Rear Carter Carter Central	2CP06500630001	2CP06500630003	2CP06500630004	2CP06500630005	2CP06500630006
5 Side Doors Portas Laterais	2CP05000630001	-	2CP05000630004	2CP05000630005	2CP05000630006
6 Front Bumper Pára-choques Frontal	2CP06200630001	-	2CP06200630004	2CP06200630005	2CP06200630006
7 Bottom side bar Embaladeiras	2CP05700630001	-	2CP05700630004	2CP05700630005	2CP05700630006
8 Rear extenders Alargadores de trás	2CP05200420001	-	2CP05200420004	2CP05200420005	2CP05200420006
9 Front extenders Alargadores da frente	2CP05200420001	-	2CP05200420004	2CP05200420005	2CP05200420006

DTC XT 800/1000 12-15	● BLACK	● BLUE	● RED	○ WHITE	● YELLOW	● ORANGE
0 Complet Kit Kit Completo	2CP14700630300	2CP14700630400	2CP14700630500	2CP14700630600	2CP14700630700	2CP14700630900
1 Front A-arms Triângulos da frente	2CP04500630300	2CP04500630400	2CP04500630500	2CP04500630600	2CP04500630700	2CP04500630900
2 Central Carter Carter Central	2CP14300630300	2CP14300630400	2CP14300630500	2CP14300630600	2CP14300630700	2CP14300630900
3 Front Carter Carter Frente	2CP14400630300	2CP14400630400	2CP14400630500	2CP14400630600	2CP14400630700	2CP14400630900
4 Rear Carter Carter Trás	2CP14500630300	2CP14500630400	2CP14500630500	2CP14500630600	2CP14500630700	2CP14500630900



DORS XT 800/1000 12-15	● BLACK	● BLUE	● RED	○ WHITE	● YELLOW	● ORANGE
0 FRAME ICE MATTE	2CP14800630301	2CP14800630401	2CP14800630501	2CP14800630601	2CP14800630701	2CP14800630801



DORS XT 800/1000 12-15	● BLACK	● BLUE	● RED	○ WHITE	● YELLOW	● ORANGE
1 FRAME BLACK	2CP14800630305	2CP14800630405	2CP14800630505	2CP14800630605	2CP14800630705	2CP14800630805

CAN-AM MAVERICK 1000 2013



Available in various colors
See page: 147

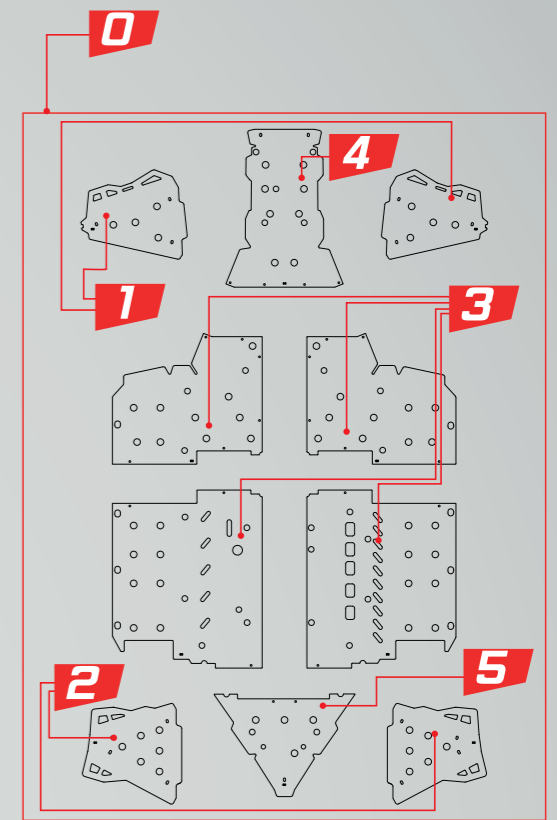

10

ALUMINUM MAVERICK 1000	● ICE MATTE	● NEUTRAL	● BLACK	● TEXT. BLACK	○ WHITE
0 Complet Kit Kit Completo	2CP05600880001	2CP05600880003	2CP05600880004	2CP05600880005	2CP05600880006
1 Front A-arms Triângulos da frente	2CP03800880001	2CP03800880003	2CP03800880004	2CP03800880005	2CP03800880006
2 Rear A-arms Triângulos de trás	2CP03900880001	2CP03900880003	2CP03900880004	2CP03900880005	2CP03900880006
3 Central Carter Carter Central	2CP06600880001	2CP06600880003	2CP06600880004	2CP06600880005	2CP06600880006
4 Front Carter Carter Frente	2CP06400880001	2CP06400880003	2CP06400880004	2CP06400880005	2CP06400880006
5 Rear Carter Carter Traseiro	2CP06500880001	2CP06500880003	2CP06500880004	2CP06500880005	2CP06500880006
6 Side Doors Portas Laterais	2CP05000880001	-	2CP05000880004	2CP05000880005	2CP05000880006
7 Front Bumper Pára-choques Frontal	2CP06200880001	-	2CP06200880004	2CP06200880005	2CP06200880006
8 Rear Bumper Pára-choques trás	2CP06300880001	-	2CP06300880004	2CP06300880005	2CP06300880006
9 Bottom side bar Embaladeiras	2CP05700880001	2CP05700880003	2CP05700880004	2CP05700880005	2CP05700880006
10 Rear extenders Alargadores de trás	2CP05200420001	-	2CP05200420004	2CP05200420005	2CP05200420006
11 Front extenders Alargadores da frente	2CP05200420001	-	2CP05200420004	2CP05200420005	2CP05200420006
12 Roof Tejadilho	-	-	2CP17500880004	2CP17500880005	2CP17500880006



DORS MAVERICK 1000	● BLACK	● BLUE	● RED	○ WHITE	● YELLOW	● ORANGE
6 FRAME ICE MATTE	2CP14800880301	2CP14800880401	2CP14800880501	2CP14800880601	2CP14800880701	2CP14800880801



DORS MAVERICK 1000	● BLACK	● BLUE	● RED	○ WHITE	● YELLOW	● ORANGE
6 FRAME BLACK	2CP14800880305	2CP14800880405	2CP14800880505	2CP14800880605	2CP14800880705	2CP14800880805

DTC MAVERICK 1000	● BLACK	● BLUE	● RED	○ WHITE	● YELLOW	● ORANGE
0 Complet Kit Kit Completo	2CP14700880300	2CP14700880400	2CP14700880500	2CP14700880600	2CP14700880700	2CP14700880900
1 Front A-arms Triângulos da frente	2CP04500880300	2CP04500880400	2CP04500880500	2CP04500880600	2CP04500880700	2CP04500880900
2 Rear A-arms Triângulos de trás	2CP11600880300	2CP11600880400	2CP11600880500	2CP11600880600	2CP11600880700	2CP11600880900
3 Central Carter Carter Central	2CP14300880300	2CP14300880400	2CP14300880500	2CP14300880600	2CP14300880700	2CP14300880900
4 Front Carter Carter Frente	2CP14400880300	2CP14400880400	2CP14400880500	2CP14400880600	2CP14400880700	2CP14400880900
5 Rear Carter Carter Traseiro	2CP14500880300	2CP14500880400	2CP14500880500	2CP14500880600	2CP14500880700	2CP14500880900
7 Roof 8mm Tejadilho 8mm	2CP17400880300	-	-	-	-	-

CAN-AM

MAVERICK X3

TURBO/X DS* / X RC/X RS

2017-2019

Available in various colors
See page: 147

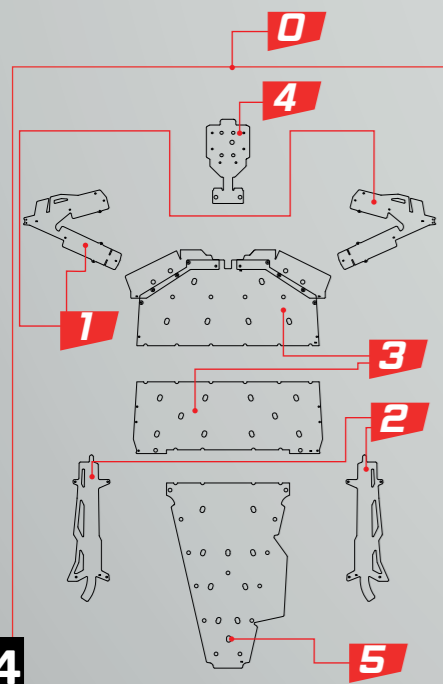

DTC MAVERICK X3		● BLACK
2	Rear A-arms (6mm) Triângulos de trás *not for XD S	2CP11600940300
3	Central Carter (8mm) Carter Central	2CP19000940300
4	Front Carter (6mm) Carter Frente	2CP14400940300
5	Rear Carter (8mm) Carter trás	2CP19200940300

ALUMINUM MAVERICK X3		● ICE MATTE	● NEUTRAL	● BLACK	● TEXT. BLACK	○ WHITE
0	Complet Kit *not for XD S Kit Completo	2CP05600940001	2CP05600940003	2CP05600940004	2CP05600940005	2CP05600940006
1	Front A-arms Triângulos da frente *not for XD S	2CP03800940001	2CP03800940003	2CP03800940004	2CP03800940005	2CP03800940006
2	Rear A-arms Triângulos de trás *not for XD S	2CP03900940001	2CP03900940003	2CP03900940004	2CP03900940005	2CP03900940006
3	Central Carter Carter Central	2CP06600940001	2CP06600940003	2CP06600940004	2CP06600940005	2CP06600940006
4	Front Carter Carter Frente	2CP06400940001	2CP06400940003	2CP06400940004	2CP06400940005	2CP06400940006
5	Rear Carter Carter Traseiro	2CP06500940001	2CP06500940003	2CP06500940004	2CP06500940005	2CP06500940006
6	Side Doors Portas Laterais	2CP05000940001	-	2CP05000940004	2CP05000940005	2CP05000940006
*6	Cover for original Doors Capa p/ Portas (originais)	2CP0500A940001	-	2CP0500A940004	2CP0500A940005	2CP0500A940006
7	Front Bumper Para-choques Frontal	2CP062094A0001	-	2CP062094A0004	2CP062094A0005	2CP062094A0006
9	Bottom side bar Embaladeiras	2CP05700940001	-	2CP05700940004	2CP05700940005	2CP05700940006
10	Rear extenders Alargadores de trás	2CP05200550001	-	2CP05200550004	2CP05200550005	2CP05200550006
11	Front extenders Alargadores da frente	2CP05200550001	-	2CP05200550004	2CP05200550005	2CP05200550006

// TRAILER HITCH



Trailer Hitch (Support only) 2CP19400010004
Trailer Ball (Ball only) RP23400100

DORS MAVERICK X3

6 FRAME ICE MATTE		● BLACK	● BLUE	● RED	○ WHITE	● YELLOW	● ORANGE
		2CP14800940301	2CP14800940401	2CP14800940501	2CP14800940601	2CP14800940701	2CP14800940801

DORS MAVERICK X3

6 FRAME BLACK		● BLACK	● BLUE	● RED	○ WHITE	● YELLOW	● ORANGE
		2CP14800940305	2CP14800940405	2CP14800940505	2CP14800940605	2CP14800940705	2CP14800940805

ride and ENJOY IT

POLARIS

RZR

800/800s

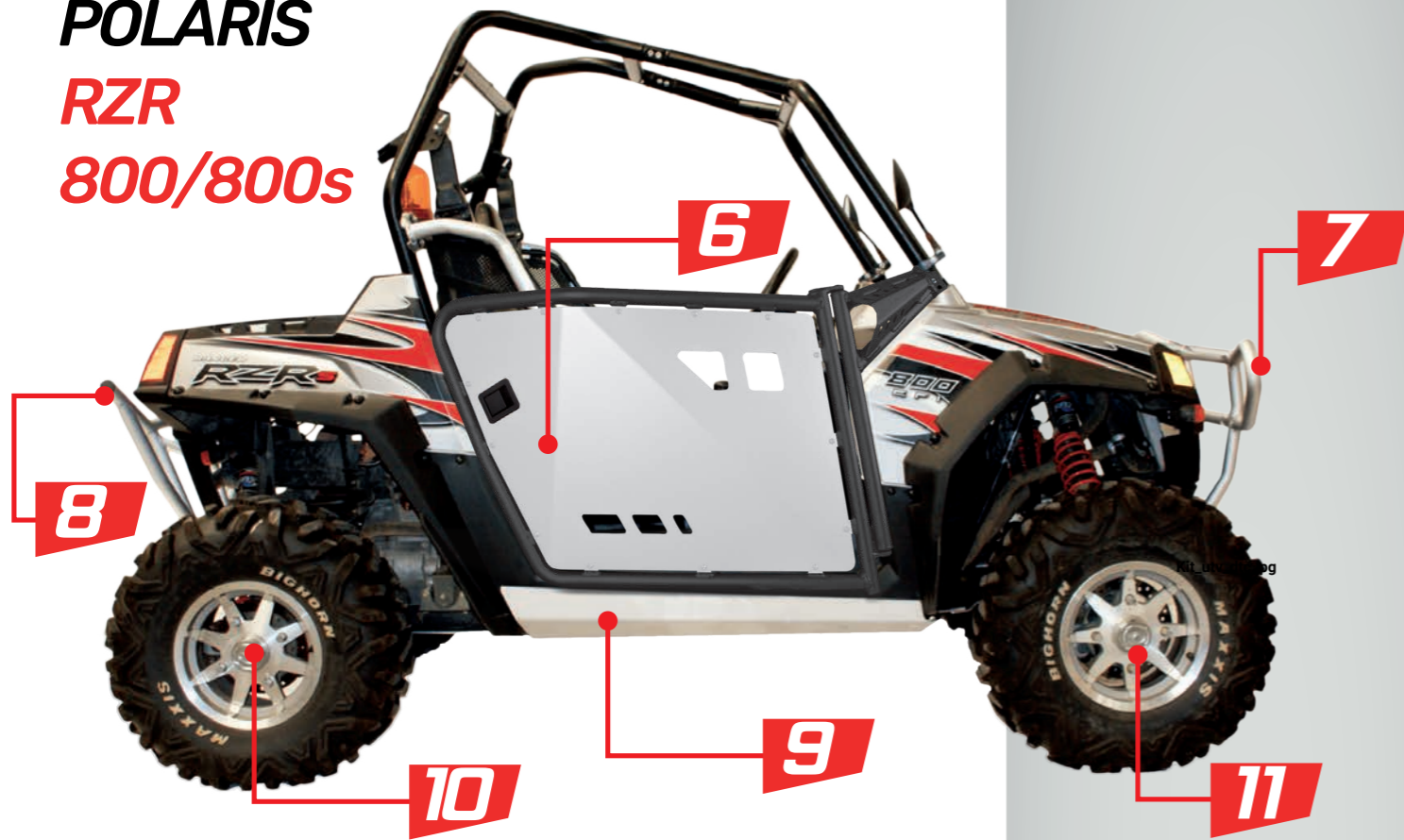

ALUMINUM	● ICE MATTE	● NEUTRAL	● BLACK	● TEXT. BLACK	○ WHITE
RZR 800 08-14					
0 Complet Kit Kit Completo	2CP05600450001	2CP05600450003	2CP05600450004	2CP05600450005	2CP05600450006
1 Front A-arms Triângulos da frente	2CP03800450001	2CP03800450003	2CP03800450004	2CP03800450005	2CP03800450006
2 Rear A-arms Triângulos de trás	2CP03900450001	2CP03900450003	2CP03900450004	2CP03900450005	2CP03900450006
3 Central Carter Carter Central	2CP06600450001	2CP06600450003	2CP06600450004	2CP06600450005	2CP06600450006
4 Front Carter Carter Frente	2CP06400450001	2CP06400450003	2CP06400450004	2CP06400450005	2CP06400450006
5 Rear Carter Carter Traseiro	2CP06500450001	2CP06500450003	2CP06500450004	2CP06500450005	2CP06500450006
6 Side Doors Portas Laterais	2CP05000450001	-	2CP05000450004	2CP05000450005	2CP05000450006
7 Front Bumper Pára-choques Frontal	2CP06200450001	-	2CP06200450004	2CP06200450005	2CP06200450006
8 Rear Bumper Pára-choques trás	2CP06300450001	-	2CP06300450004	2CP06300450005	2CP06300450006
9 Bottom side bar Embaladeiras	2CP05700450001	-	2CP05700450004	2CP05700450005	2CP05700450006
10 Rear extenders Alargadores de trás	2CP05200320001	-	2CP05200320004	2CP05200320005	2CP05200320006
11 Front extenders Alargadores da frente	2CP05200320001	-	2CP05200320004	2CP05200320005	2CP05200320006

ALUMINUM	● ICE MATTE	● NEUTRAL	● BLACK	● TEXT. BLACK	○ WHITE
RZR 800s 09-14					
0 Complet Kit Kit Completo	2CP05600660001	2CP05600660003	2CP05600660004	2CP05600660005	2CP05600660006
1 Front A-arms Triângulos da frente	2CP03800660001	2CP03800660003	2CP03800660004	2CP03800660005	2CP03800660006
2 Rear A-arms Triângulos de trás	2CP03900660001	2CP03900660003	2CP03900660004	2CP03900660005	2CP03900660006
3 Central Carter Carter Central	2CP06600450001	2CP06600450003	2CP06600450004	2CP06600450005	2CP06600450006
4 Front Carter Carter Frente	2CP06400450001	2CP06400450003	2CP06400450004	2CP06400450005	2CP06400450006
5 Rear Carter Carter Traseiro	2CP06500660001	2CP06500660003	2CP06500660004	2CP06500660005	2CP06500660006
6 Side Doors Portas Laterais	2CP05000450001	-	2CP05000450004	2CP05000450005	2CP05000450006
7 Front Bumper Pára-choques Frontal	2CP06200450001	-	2CP06200450004	2CP06200450005	2CP06200450006
8 Rear Bumper Pára-choques trás	2CP06300450001	-	2CP06300450004	2CP06300450005	2CP06300450006
9 Bottom side bar Embaladeiras	2CP05700660001	-	2CP05700660004	2CP05700660005	2CP05700660006
10 Rear extenders Alargadores de trás	2CP05200320001	-	2CP05200320004	2CP05200320005	2CP05200320006
11 Front extenders Alargadores da frente	2CP05200320001	-	2CP05200320004	2CP05200320005	2CP05200320006

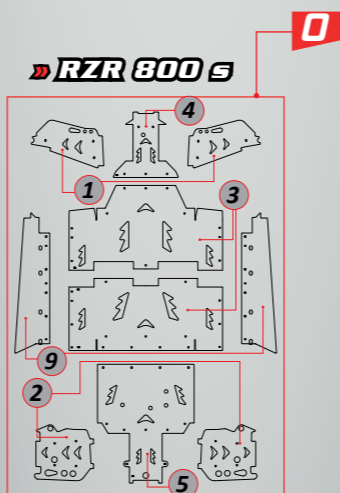
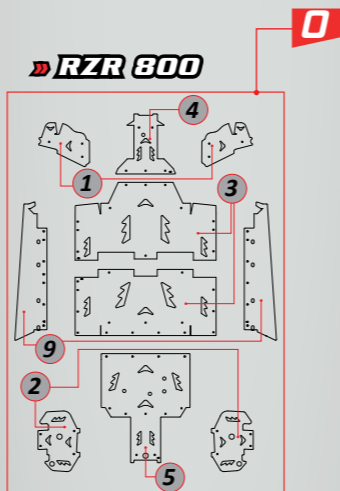

Available in various colors
See page: 147



DORS	● BLACK	● BLUE	● RED	○ WHITE	● YELLOW	● ORANGE
RZR 800 08-14						
6 ● FRAME ICE MATTE	2CP14800450301	2CP14800450401	2CP14800450501	2CP14800450601	2CP14800450701	2CP14800450801

DORS	● BLACK	● BLUE	● RED	○ WHITE	● YELLOW	● ORANGE
RZR 800s 09-14						
6 ● FRAME ICE MATTE	2CP14800450301	2CP14800450401	2CP14800450501	2CP14800450601	2CP14800450701	2CP14800450801



DORS	● BLACK	● BLUE	● RED	○ WHITE	● YELLOW	● ORANGE
RZR 800 08-14						
6 ● FRAME BLACK	2CP14800450305	2CP14800450405	2CP14800450505	2CP14800450605	2CP14800450705	2CP14800450805

DORS	● BLACK	● BLUE	● RED	○ WHITE	● YELLOW	● ORANGE
RZR 800s 09-14						
6 ● FRAME BLACK	2CP14800450305	2CP14800450405	2CP14800450505	2CP14800450605	2CP14800450705	2CP14800450805



RZR 800

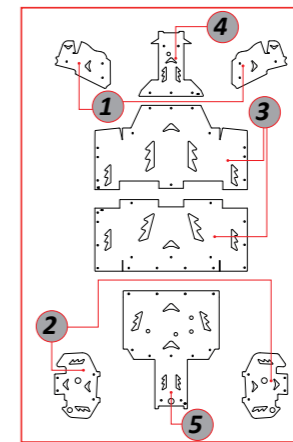

RZR 800s

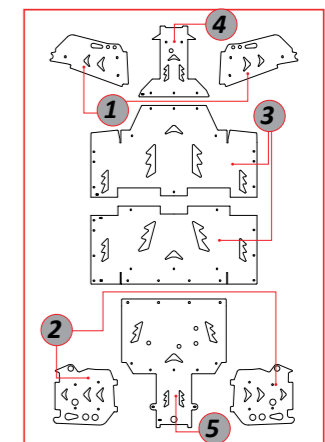

DTC	● BLACK	● BLUE	● RED	○ WHITE	● YELLOW	● ORANGE
RZR 800 08-14						
1 Front A-arms Triângulos da frente	2CP04500450300	2CP04500450400	2CP04500450500	2CP04500450600	2CP04500450700	2CP04500450900
2 Rear A-arms Triângulos de trás	2CP11600450300	2CP11600450400	2CP11600450500	2CP11600450600	2CP11600450700	2CP11600450900
3 Central Carter Carter Central	2CP14300450300	2CP14300450400	2CP14300450500	2CP14300450600	2CP14300450700	2CP14300450900
4 Front Carter Carter Frente	2CP14400450300	2CP14400450400	2CP14400450500	2CP14400450600	2CP14400450700	2CP14400450900
5 Rear Carter Carter Traseiro	2CP14500450300	2CP14500450400	2CP14500450500	2CP14500450600	2CP14500450700	2CP14500450900

DTC	● BLACK	● BLUE	● RED	○ WHITE	● YELLOW	● ORANGE
RZR 800s 09-14						
1 Front A-arms Triângulos da frente	2CP04500660300	2CP04500660400	2CP04500660500	2CP04500660600	2CP04500660700	2CP04500660900
2 Rear A-arms Triângulos de trás	2CP11600660300	2CP11600660400	2CP11600660500	2CP11600660600	2CP11600660700	2CP11600660900
3 Central Carter Carter Central	2CP14300450300	2CP14300450400	2CP14300450500	2CP14300450600	2CP14300450700	2CP14300450900
4 Front Carter Carter Frente	2CP14400450300	2CP14400450400	2CP14400450500	2CP14400450600	2CP14400450700	2CP14400450900
5 Rear Carter Carter Traseiro	2CP14500660300	2CP14500660400	2CP14500660500	2CP14500660600	2CP14500660700	2CP14500660900

ride and ENJOY IT

POLARIS

RZR 900

2011-2014

Available in various colors
See page: 147

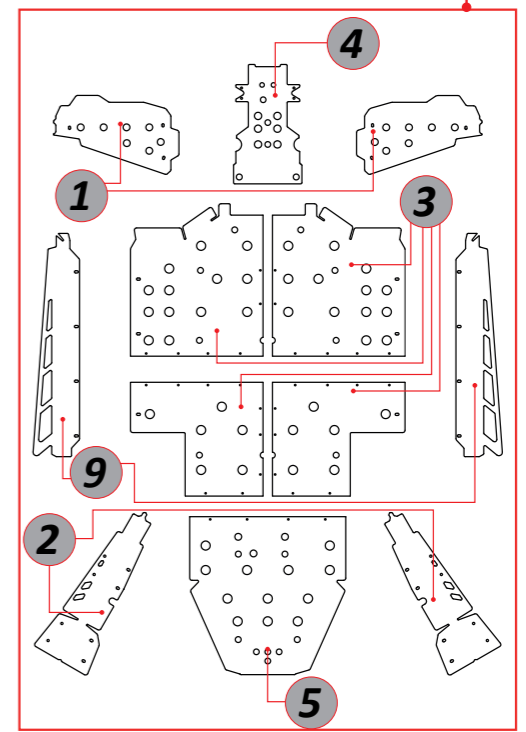

ALUMINUM RZR 900 11-14	● ICE MATTE	● NEUTRAL	● BLACK	● TEXT. BLACK	○ WHITE
0 Complet Kit Kit Completo	2CP05600780001	2CP05600780003	2CP05600780004	2CP05600780005	2CP05600780006
1 Front A-arms Triângulos da frente	2CP03800780001	2CP03800780003	2CP03800780004	2CP03800780005	2CP03800780006
2 Rear A-arms Triângulos de trás	2CP03900780001	2CP03900780003	2CP03900780004	2CP03900780005	2CP03900780006
3 Central Carter Carter Central	2CP06600780001	2CP06600780003	2CP06600780004	2CP06600780005	2CP06600780006
4 Front Carter Carter Frente	2CP06400780001	2CP06400780003	2CP06400780004	2CP06400780005	2CP06400780006
5 Rear Carter Carter Traseiro	2CP06500780001	2CP06500780003	2CP06500780004	2CP06500780005	2CP06500780006
6 Side Doors Portas Laterais	2CP05000780001	-	2CP05000780004	2CP05000780005	2CP05000780006
7 Front Bumper Pára-choques Frontal	2CP06200780001	-	2CP06200780004	2CP06200780005	2CP06200780006
8 Rear Bumper Pára-choques trás	2CP06300780001	-	2CP06300780004	2CP06300780005	2CP06300780006
9 Bottom side bar Embaladeiras	2CP05700780001	-	2CP05700780004	2CP05700780005	2CP05700780006
10 Rear extenders Alargadores de trás	2CP05200320001	-	2CP05200320004	2CP05200320005	2CP05200320006
11 Front extenders Alargadores da frente	2CP05200320001	-	2CP05200320004	2CP05200320005	2CP05200320006

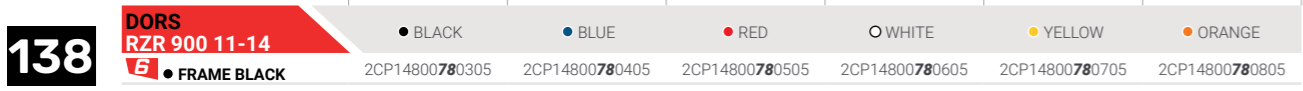

DTC RZR 900 11-14	● BLACK	● BLUE	● RED	○ WHITE	● YELLOW	● ORANGE
1 Front A-arms Triângulos da frente	2CP04500780300	2CP04500780400	2CP04500780500	2CP04500780600	2CP04500780700	2CP04500780900
2 Rear A-arms Triângulos de trás	2CP11600780300	2CP11600780400	2CP11600780500	2CP11600780600	2CP11600780700	2CP11600780900
3 Central Carter Carter Central	2CP14300780300	2CP14300780400	2CP14300780500	2CP14300780600	2CP14300780700	2CP14300780900
4 Front Carter Carter Frente	2CP14400780300	2CP14400780400	2CP14400780500	2CP14400780600	2CP14400780700	2CP14400780900
5 Rear Carter Carter Traseiro	2CP14500780300	2CP14500780400	2CP14500780500	2CP14500780600	2CP14500780700	2CP14500780900

POLARIS

RZR 900s

2015



Available in various colors
See page: 147

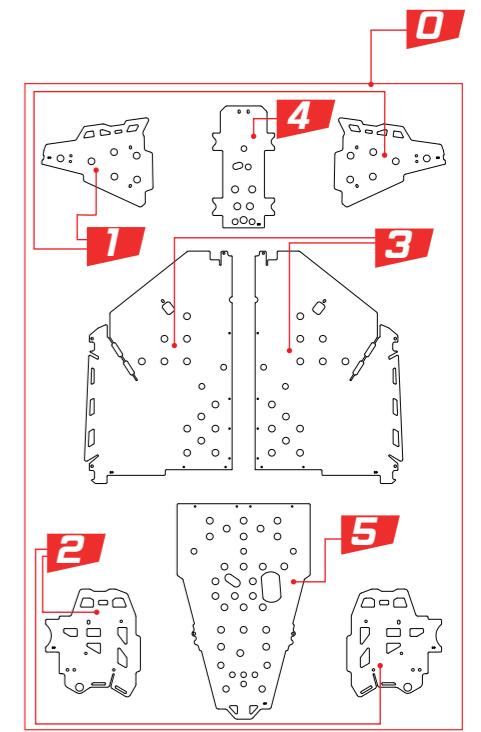

DORS RZR 900s 2015	BLACK	BLUE	RED	WHITE	YELLOW	ORANGE
5 FRAME ICE MATTE	2CP14800890301	2CP14800890401	2CP14800890501	2CP14800890601	2CP14800890701	2CP14800890801



DORS RZR 900s 2015	BLACK	BLUE	RED	WHITE	YELLOW	ORANGE
5 FRAME BLACK	2CP14800890305	2CP14800890405	2CP14800890505	2CP14800890605	2CP14800890705	2CP14800890805

ALUMINUM RZR 900s 2015	ICE MATTE	NEUTRAL	BLACK	TEXT. BLACK	WHITE
0 Complet Kit Kit Completo	2CP05600890001	2CP05600890003	2CP05600890004	2CP05600890005	2CP05600890006
1 Front A-arms Triângulos da frente	2CP03800890001	2CP03800890003	2CP03800890004	2CP03800890005	2CP03800890006
2 Rear A-arms Triângulos de trás	2CP03900890001	2CP03900890003	2CP03900890004	2CP03900890005	2CP03900890006
3 Central Carter Carter Central	2CP06600890001	2CP06600890003	2CP06600890004	2CP06600890005	2CP06600890006
4 Front Carter Carter Frente	2CP06400890001	2CP06400890003	2CP06400890004	2CP06400890005	2CP06400890006
5 Rear Carter Carter Traseiro	2CP06500890001	2CP06500890003	2CP06500890004	2CP06500890005	2CP06500890006
6 Side Doors Portas Laterais	2CP05000890001	-	2CP05000890004	2CP05000890005	2CP05000890006
7 Front Bumper Pára-choques Frontal	2CP06200870___	-	2CP06200870___	2CP06200870___	2CP06200870___
8 Rear Bumper Pára-choques trás	2CP06300890001	-	2CP06300890004	2CP06300890005	2CP06300890006
9 Bottom side bar Embaladeiras	2CP05700870001	-	2CP05700870004	2CP05700870005	2CP05700870006
10 Rear extenders Alargadores de trás	2CP05200460001	-	2CP05200460004	2CP05200460005	2CP05200460006
11 Front extenders Alargadores da frente	2CP05200460001	-	2CP05200460004	2CP05200460005	2CP05200460006
12 Roof Tejadilho	-	2CP17500870003	2CP17500870004	2CP17500870005	2CP17500870006

DTC RZR 900s 2015	BLACK	BLUE	RED	WHITE	YELLOW	ORANGE
0 Complet Kit Kit Completo	2CP14700890300	2CP14700890400	2CP14700890500	2CP14700890600	2CP14700890700	2CP14700890900
1 Front A-arms Triângulos da frente	2CP04500890300	2CP04500890400	2CP04500890500	2CP04500890600	2CP04500890700	2CP04500890900
2 Rear A-arms Triângulos de trás	2CP11600890300	2CP11600890400	2CP11600890500	2CP11600890600	2CP11600890700	2CP11600890900
3 Central Carter Carter Central	2CP14300890300	2CP14300890400	2CP14300890500	2CP14300890600	2CP14300890700	2CP14300890900
4 Front Carter Carter Frente	2CP14400890300	2CP14400890400	2CP14400890500	2CP14400890600	2CP14400890700	2CP14400890900
5 Rear Carter Carter Trás	2CP14500890300	2CP14500890400	2CP14500890500	2CP14500890600	2CP14500890700	2CP14500890900
7 Roof 6mm Tejadilho 6mm	2CP17300870300	-	-	-	-	-

ride and ENJOY IT

POLARIS

RZR 1000

2014-2015



Available in various colors
See page: 147

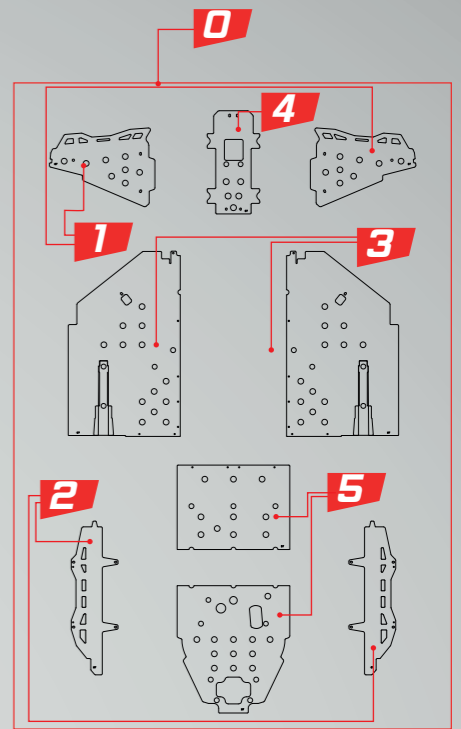

DORS RZR 1000 14-15	● BLACK	● BLUE	● RED	○ WHITE	● YELLOW	● ORANGE
6 FRAME ICE MATTE	2CP14800870301	2CP14800870401	2CP14800870501	2CP14800870601	2CP14800870701	2CP14800870801



DORS RZR 1000 14-15	● BLACK	● BLUE	● RED	○ WHITE	● YELLOW	● ORANGE
6 FRAME BLACK	2CP14800870305	2CP14800870405	2CP14800870505	2CP14800870605	2CP14800870705	2CP14800870805

ALUMINUM RZR 1000 14-15	● ICE MATTE	● NEUTRAL	● BLACK	● TEXT. BLACK	○ WHITE
0 Complet Kit Kit Completo	2CP05600870001	2CP05600870003	2CP05600870004	2CP05600870005	2CP05600870006
1 Front A-arms Triângulos da frente	2CP03800870001	2CP03800870003	2CP03800870004	2CP03800870005	2CP03800870006
2 Rear A-arms Triângulos de trás	2CP03900870001	2CP03900870003	2CP03900870004	2CP03900870005	2CP03900870006
3 Central Carter Carter Central	2CP06600870001	2CP06600870003	2CP06600870004	2CP06600870005	2CP06600870006
4 Front Carter Carter Frente	2CP06400870001	2CP06400870003	2CP06400870004	2CP06400870005	2CP06400870006
5 Rear Carter Carter Traseiro	2CP06500870001	2CP06500870003	2CP06500870004	2CP06500870005	2CP06500870006
6 Side Doors Portas Laterais	2CP05000870001	2CP05000870003	2CP05000870004	2CP05000870005	2CP05000870006
7 Front Bumper Para-choques Frontal	2CP06200870___	-	2CP06200870___	2CP06200870___	2CP06200870___
8 Rear Bumper Para-choques trás	2CP06300870001	-	2CP06300870004	2CP06300870005	2CP06300870006
9 Bottom side bar Embaladeiras	2CP05700870001	-	2CP05700870004	2CP05700870005	2CP05700870006
10 Rear extenders Alargadores de trás	2CP05200440001	-	2CP05200440004	2CP05200440005	2CP05200440006
11 Front extenders Alargadores da frente	2CP05200440001	-	2CP05200440004	2CP05200440005	2CP05200440006
12 Roof Tejadilho	-	2CP17500870003	2CP17500870004	2CP17500870005	2CP17500870006

DTC RZR 1000 14-15	● BLACK	● BLUE	● RED	○ WHITE	● YELLOW	● ORANGE
0 Complet Kit Kit Completo	2CP14700870300	2CP14700870400	2CP14700870500	2CP14700870600	2CP14700870700	2CP14700870900
1 Front A-arms Triângulos da frente	2CP04500870300	2CP04500870400	2CP04500870500	2CP04500870600	2CP04500870700	2CP04500870900
2 Rear A-arms Triângulos de trás	2CP11600870300	2CP11600870400	2CP11600870500	2CP11600870600	2CP11600870700	2CP11600870900
3 Central Carter Carter Central	2CP14300870300	2CP14300870400	2CP14300870500	2CP14300870600	2CP14300870700	2CP14300870900
4 Front Carter Carter Frente	2CP14400870300	2CP14400870400	2CP14400870500	2CP14400870600	2CP14400870700	2CP14400870900
5 Rear Carter Carter Trás	2CP14500870300	2CP14500870400	2CP14500870500	2CP14500870600	2CP14500870700	2CP14500870900
T Roof 6mm Tejadilho 6mm	2CP17300870300	-	-	-	-	-

CROSSPRO AROUND THE WORLD

A CROSSPRO prima pela excelência e rigor na procura e desenvolvimento de novas soluções, com produtos inovadores de alta qualidade que vão ao encontro da exigência dos nossos clientes e da procura do mercado.

Antevendo sempre todas as exigências, a CROSSPRO ao longo da sua existência aumentou a sua gama de produtos e atualmente está presente em mais de 40 países .

A internacionalização foi sem dúvida um passo decisivo para exponenciar as vendas representando cerca de 95% da produção atual.

Made by CROSSPRO

CROSSPRO stands out for excellence and rigor in the research and development of new solutions, with innovative high quality products that meet the demands of our customers and the market itself.

Always anticipating all requirements, CROSSPRO during its existence has increased its range of products and is currently present in more than 40 countries all over the world.

Internationalization was undoubtedly a decisive step to increase sales, representing around 95% of current production.

Made by CROSSPRO

Europe

Áustria
Belgium
Cyprus
Czech Republic
Denmark
Finland
France
Germany
Greece
Holland
Hungary
Italy
Latvia
Lithuania
Norway
Poland
Portugal
Romania
Slovakia
Slovenia
Spain
Sweden
Switzerland
United Kingdom

Asia

Dubai
Iran
Israel
Japan
Kwait
Malaysia
Philippines
Russia
Singapore
Thailand
Turkey

AMERICA

Argentina
Canada
Chile
USA
Mexico

OCEANIA

Australia
New Zealand

AFRICA

South Africa
Morocco



ELECTROSTATIC PAINT PROCESS

 *Indicative weights*
Pesos indicativos

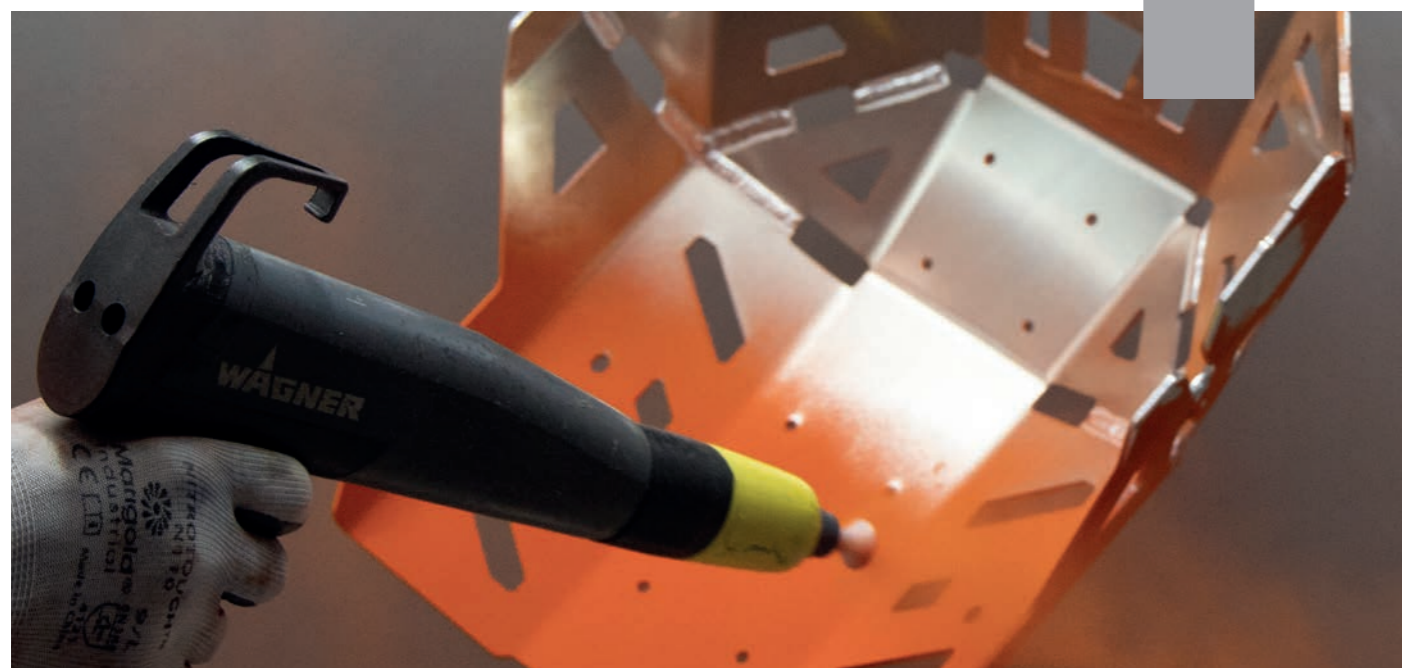

A pintura é realizada por lacagem, que consiste num processo de pintura eletrostático executado com tintas em pó.

Este processo, bem como o tratamento a que as peças são sujeitas, reforça a proteção anticorrosiva e maximiza a adesão e duração da tinta.

No nosso processo de lacagem dispomos de 9 cores diferentes para as suas proteções.

Um processo simples, eficaz e resistente.

The painting is carried out by the lacquering method, which consists of an electrostatic painting process performed with powder paints.

This process, together with a final treatment technique applied to the pieces, reinforces the anti-corrosion protection and maximizes the adhesion and duration of the paint.

With this lacquering process we have 9 different colors for the protections.









A simple, effective and resistant process.



“Painting is done through lacquering, which is an electrostatic painting process performed with powder paints.”

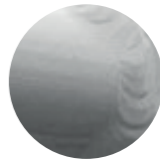

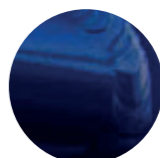
We have 12 different colors for your guards!

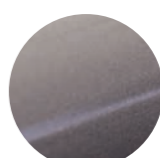
- | | | | | | |
|---|----------------------------|---|---|---|---------------------------------------|
|  | Ice Polish |  | Polish |  | Natural |
|  | Black
<i>ral: 9005</i> |  | Textured Black
<i>ral: 9005 text</i> |  | White
<i>ral: 9110</i> |
|  | Red
<i>ral: 3020</i> |  | Green
<i>ral: 6018</i> |  | Blue
<i>ral: 5002</i> |
|  | Yellow
<i>ral: 1021</i> |  | Orange
<i>ral: 2004</i> |  | Ice Polish Protected
varnish color |

CROSSPRO
PROTECTION PARTS

Zona Industrial do Paraimo, Lote 45
3780-524 - Sangalhos | Anadia | Portugal

Gps: 40°28'31.0"N 8°28'39.5"W

Phone: +351 234 629 044
www.crosspro.pt
E-mail: geral@crosspro.pt

2CPCATOR23



Management
System
ISO 9001:2015



www.tuv.com
ID 910507726